

cinquanta3

stanze
su misura

accoglienti
e funzionali

presenta

home
spaces



manifesto p. 2

living rooms p. 4

bedrooms p. 42

utility rooms p. 112

**customizable
elements** p. 136

home spaces
presents custom,
cosy and functional
rooms planned using
the flexibility and
extensive modularity
of cinquanta3™

**home
spaces**

MANIFESTO

cinquanta3 nasce per rispondere alle tendenze ed esigenze del vivere contemporaneo che invita a ricercare soluzioni funzionali e flessibili, capaci di organizzare e contenere, definire e interpretare gli spazi del quotidiano. Un nuovo sistema d'arredo dove la massima libertà compositiva è garantita da ampia modularità e tonalità neutre, e la personalizzazione degli ambienti si esprime nell'ampia gamma di accessori e nella versatilità dei prodotti.

In **home spaces** gli elementi d'arredo diventano strutture architettoniche che creano nuove forme di contenimento, capaci di definire i diversi ambienti della casa e accogliere le passioni e la storia di chi li vive.

cinquanta3 was conceived to meet the trends and requirements of contemporary lifestyles that need functional, flexible solutions able to organise and contain, define and interpret everyday spaces. This is a new furnishing system that offers utmost freedom of arrangement thanks to the many module sizes and neutral shades available. Living spaces can be customised by means of a wide range of accessories and by virtue of the versatility of the units.

The furniture employed by **home spaces** turns into pieces of architecture that become new storage elements, capable of defining the various rooms in a home and of containing the passions and history of its inhabitants.

zone giorno razionali

progettate
per contenere

trasformare

e ridefinire
gli spazi

rational living
areas designed
to contain, transform
and redefine spaces.

L1



p. 6

L2



p. 14

L3



p. 20

L4



p. 28

L5



p. 34

LI

A
basi a terra
 in finitura olmo
 shade, maniglia A47
 in finitura bianco.

floorstanding base units in olmo
 shade finish, bianco-coloured A47 handle.

C
libreria a terra con ante
 in finitura olmo shade.

floorstanding bookcase with doors in olmo shade finish.

B
pensili e casellari
 in finitura castoro e cashmere.

closed and open wall units in castoro and cashmere finish.

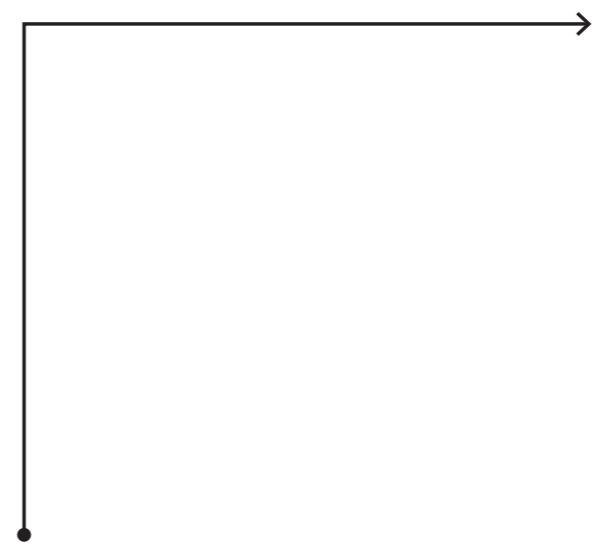
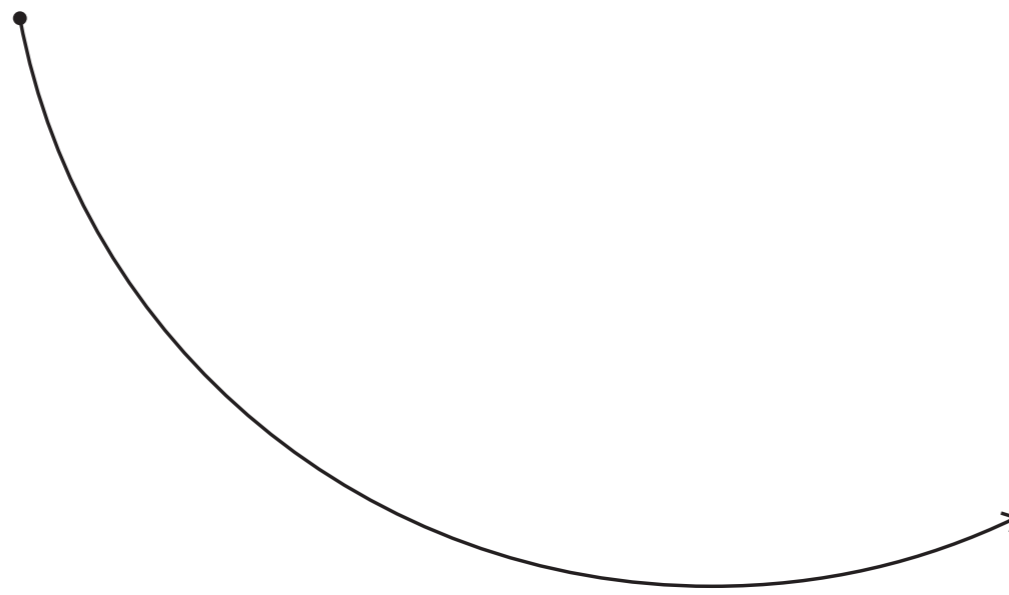
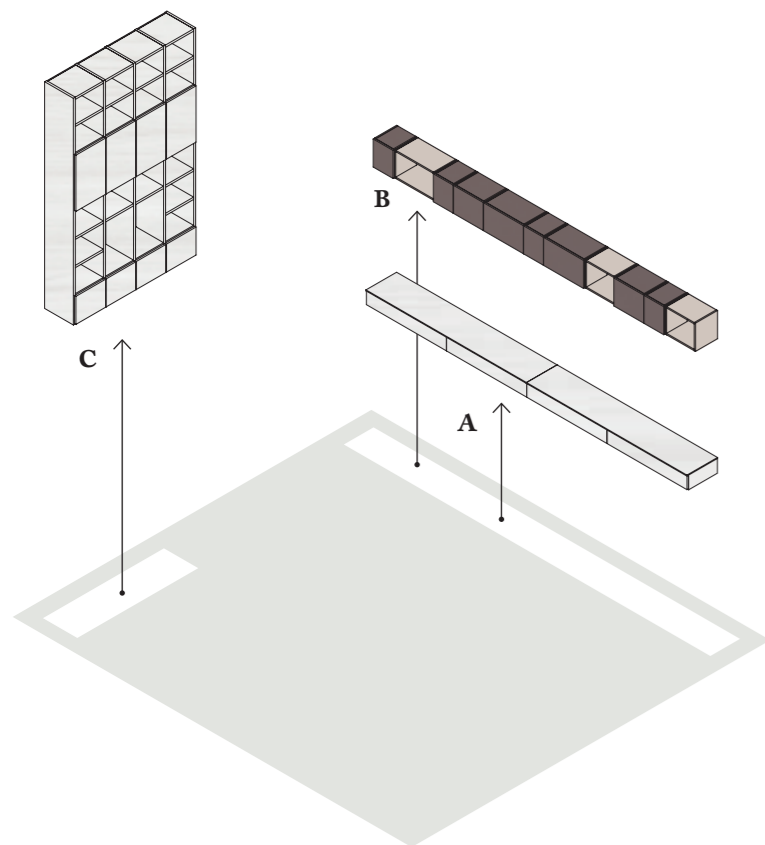

KEY PRODUCT

**pensili
e casellari**
—
**closed and
open wall units**

L—W 480 H 36,6 P—D 35,4 cm

basi a terra
—
**floorstanding
base units**

L—W 480 H 21,2 P—D 45,4 cm



KEY PRODUCT

LI.1



Basi a terra in olmo tabacco con maniglia A47 brunita, **casellari Zip** in castoro, **contenitori pensili** in sabbia.

Olmo tabacco finish **floorstanding base units** with bronze finish A47 handle, castoro-coloured **Zip open wall units**, sabbia-coloured **wall units**.

LI.2



Basi sospese in grigio, **contenitori pensili** in olmo shade, **casellari Zip** in lavagna.

Grigio-coloured **wall-mounted base units**, olmo shade finish **wall units**, lavagna-coloured **Zip open wall units**.

LI.3



Pedana in folding in bianco, **basi in appoggio** con maniglia A63 bianca, **contenitori pensili** in bianco e grigio, **casellari a giorno** in cemento.

Bianco-coloured mitre-folded **plinth**, sit-on-top **base units** with bianco-coloured A63 handle, bianco and grigio-coloured **wall units**, cemento-coloured **open wall units**.

LI.4



Basi sospese, **contenitori pensili** e **mensole** in cashmere.

Wall-mounted base units, **wall units** and **shelves** in cashmere finish.

**libreria
a terra con ante
—
floorstanding
bookcase
with doors**

L—W 183 H 294,5 P—D 45,2 cm



L2

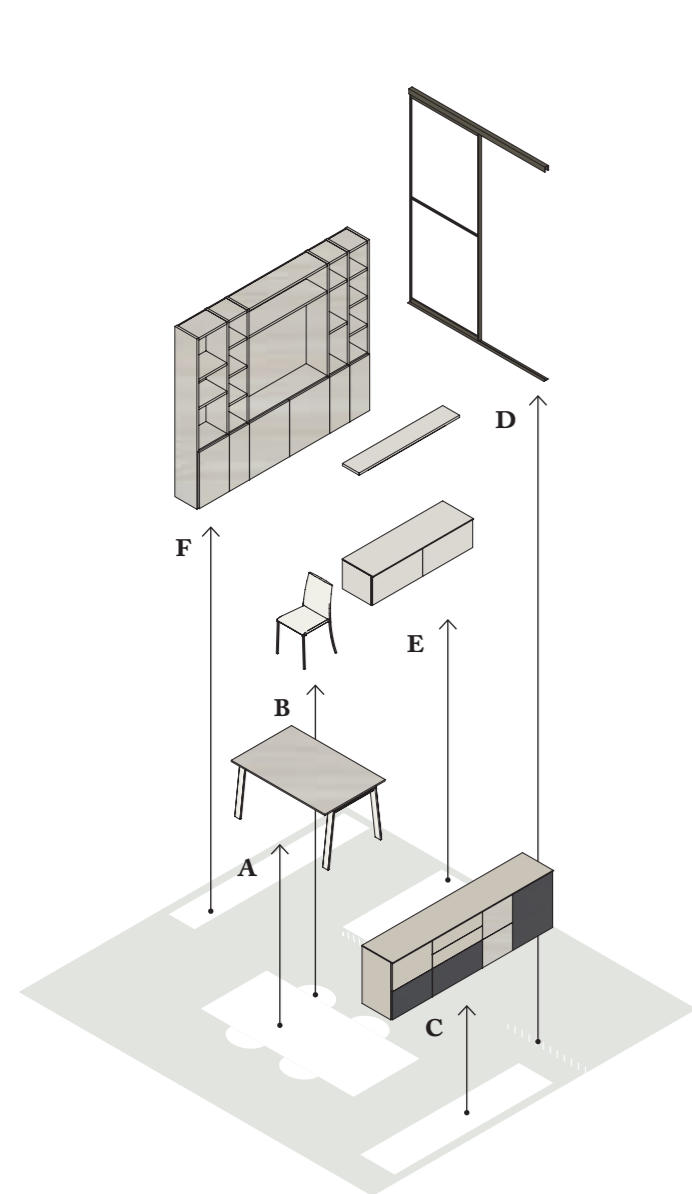

A
tavolo allungabile Corby
 piano in finitura olmo nordico,
 gambe in finitura bianco.

Corby extending table olmo nordico finish top, bianco finish legs.

B
sedia Nerja
 in finitura bianco.

Nerja chair in bianco finish.

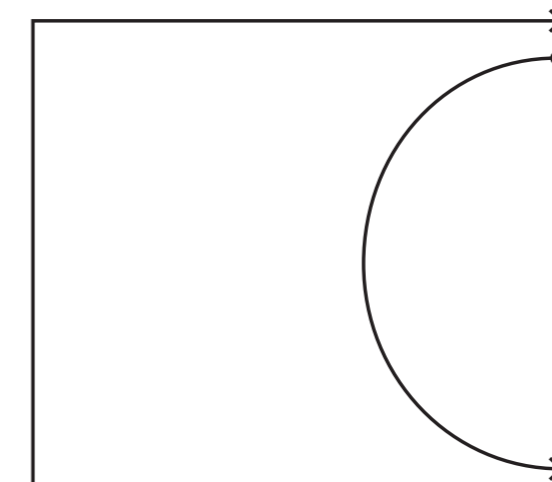

D
chiusura scorrevole a parete
 in finitura brunito.

wall sliding closing system in bronze finish.

C
libreria a terra
 in finitura olmo nordico.

floorstanding bookcase in olmo nordico finish.

E
basi a terra e mensola con tubo appendiabiti
 in finitura nuvola.

floorstanding base units and shelf with hanging rail in nuvola finish.

F
libreria a terra con ante
 in finitura olmo nordico, maniglia A54.

floorstanding bookcase with doors in olmo nordico finish, A54 handle.

**libreria a terra
—
con ante
—
floorstanding
bookcase
with doors**

L—W 258 H 221,3 P—D 35,2 cm



**basi a terra
—
floorstanding
base units**

L—W 240 H 76,1 P—D 45,4 cm

KEY PRODUCT

L2.I



Tavolo allungabile Corby a penisola in finitura lavagna con struttura brunita, **sedie Sneek** nere e verdi con basamento R2 nero.

Corby peninsula extending table in lavagna-coloured finish with bronze finish frame, black and green-coloured **Sneek chairs** with black-coloured R2 base.



**tavolo
allungabile Corby**
—
**Corby
extending table**

L—W 140/260 H 75 P—D 90 cm

L3



KEY PRODUCT

**libreria
bifacciale
con ante
—
double-sided
bookcase
with doors**

L—W 213 H 239,6 P—D 35,2 cm



**armadio
mansardato
—
wardrobe cut
to accommodate
staircase**

L—W 302,5 H 57/239,6 P—D 60,6 cm

KEY PRODUCT

L3.1



Libreria sovrapposta e a terra in grigio con schiene in olmo shade, **pedana** in folding in finitura cemento.

Grigio-coloured **sit on top and floorstanding bookcase** with olmo shade finish back panels, cemento-coloured **mitre-folded plinth**.

L3.2



Libreria a terra e a ponte in castoro con schiene in olmo nordico e pannelli sottoponte in castoro, **basi a terra** in olmo nordico con maniglia A40 brunita.

Castoro-coloured **floorstanding and bridging bookcase** with olmo nordico finish back panels and castoro-coloured panels under the bridging section, olmo nordico finish floorstanding **base units** with bronze finish A40 handle.

L3.3



Basi a terra e sospese in grigio con maniglia A72 in olmo shade, **libreria sovrapposta** in finitura lavagna.

Grigio-coloured **floorstanding and wall-mounted base units** with olmo shade finish A72 handle, lavagna-coloured **bookcase** on top.

L3.4



Basi sospese in olmo tabacco con maniglia A60 in castoro, **libreria sospesa** in sabbia con schiena in basalto.

Olmo tabacco finish **wall-mounted base units** with castoro-coloured A60 handle, sabbia-coloured **wall-mounted bookcase** with basalto-coloured back panel.



libreria a terra
—
**floorstanding
bookcase**

L—W 273 H 239,6 P—D 43 cm



scrivania
—
desk

L—W 180 H 75 P—D 120 cm

L4

A
pensili e casellari
 in finitura basalto e canapa.
 closed and open wall units in basalto and canapa finishes.

C
basi a terra
 in finitura olmo tabacco.
 floorstanding base units in olmo tabacco finish.

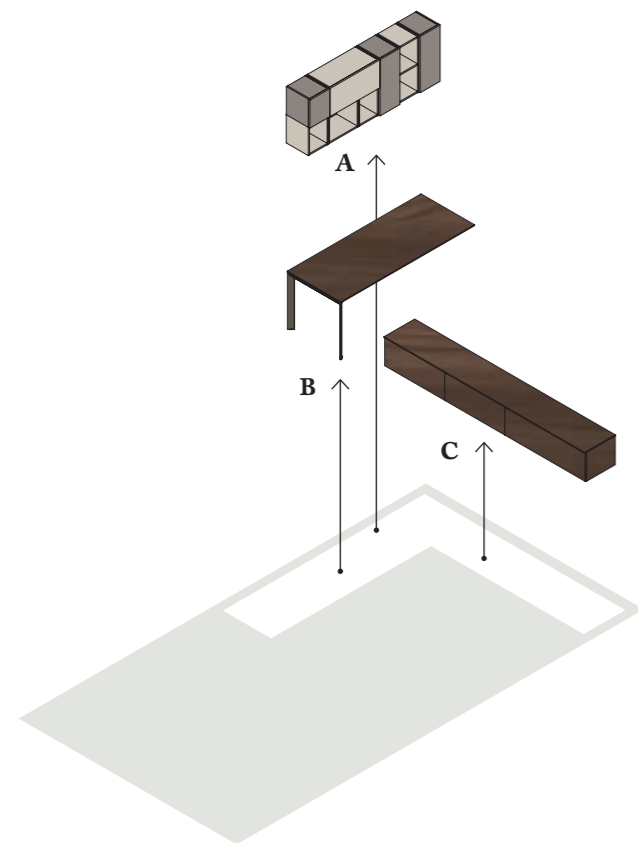

B
**scrivitoio con
 fissaggio a parete**
 top in finitura
 olmo tabacco, gambe
 in finitura brunito.
 wall-mounted desk, olmo tabacco
 finish top, bronze finish legs.

KEY PRODUCT

**pensili
e casellari
—
closed and
open wall units**

L—W 195 H 73,2 P—D 35,4 cm



**basi a terra
—
floorstanding
base units**

L—W 300 H 39,5 P—D 45,4 cm

KEY PRODUCT

L4.1



Pensili chiusi in castoro, sabbia, canapa e **casellari Zip** bianchi.

Closed wall units in castoro, sabbia, canapa finish and bianco-coloured **Zip open wall units**.

L4.2



Pensili chiusi in olmo shade e **casellari** in finitura cemento, grigio, lavagna.

Closed wall units in olmo shade finish and **open wall units** in cemento, grigio, lavagna finish.

L4.3



Pensili chiusi in nuvola e **casellari Zip** in olmo tabacco.

Nuvola finish **closed wall units** and olmo tabacco finish **Zip open wall units**.

L4.4



Pensili chiusi in grigio e **casellari** in canapa.

Grigio finish **closed wall units** and canapa finish **open wall units**.



L5

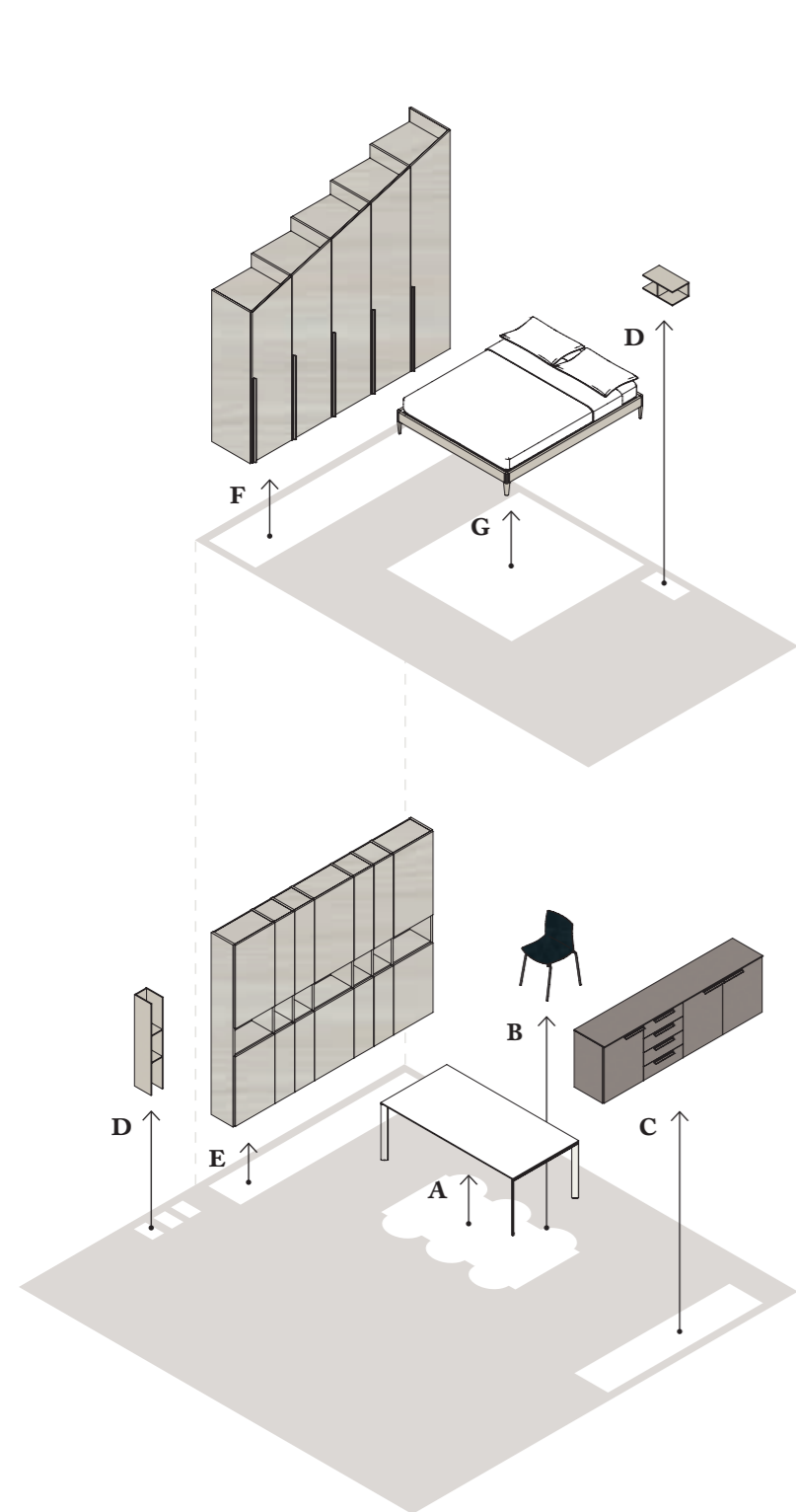

A
tavolo Vigo
 piano in vetro bianco,
 gambe in finitura bianco.

Vigo table with bianco-coloured glass top, bianco finish legs.

B
sedie Sneek imbottite
 in tessuto TF02 e TF03.

padded Sneek chairs covered in TF02 and TF03 fabric.

E
libreria a terra con ante
 in finitura olmo nordico.
 floorstanding bookcase whit doors in olmo nordico finish.

F
armadio mansardato con anta battente
 in finitura olmo nordico, maniglia A76.
 hinged door wardrobe cut for sloping ceiling in olmo nordico finish, A76 handle.

D
casellario Zip
 in finitura canapa.
 Zip open wall unit in canapa finish.

G
letto turca R120
 in finitura canapa.
 platform R120 bed in canapa finish.

C
basi a terra in finitura basalto, maniglia A74.
 floorstanding base units in basalto finish, A74 handle.

casellario Zip
—
Zip open wall unit

L—W 18,3 H 120 P—D 25 cm



KEY PRODUCT

tavolo Vigo
—
Vigo table

L—W 200 H 75 P—D 100 cm



sedia Sneek
—
Sneek chair

L—W 50,6 H 79,2 P—D 47,5 cm

KEY PRODUCT

L5.I



Tavolo Vigo con piano in vetro castoro e gambe brunite, **sedie Nerja** in testa di moro e basamento brunito.

Vigo table with castoro-coloured glass top and bronze finish legs, dark brown-coloured **Nerja chairs** with bronze finish base.

L5.I



Tavolo Leone large con piano e gambe bianchi, **sedie Sneek** con scocca in plastica gialla e basamento bianco.

Lione large table with bianco-coloured top and legs, **Sneek chairs** with yellow-coloured plastic frame and bianco-coloured base.

basi a terra
—
**floorstanding
base units**

L—W 240 H 76,1 P—D 45,4 cm



**armadio
mansardato**

—
**hinged door
wardrobe cut for
sloping ceiling**

L—W 302,5 H 190/290 P—D 60,6 cm



**letto
turca R120**

—
**platform
R120 bed**

L—W 167,8 H 29 P—D 208 cm

stanze intime e confortevoli

immaginate

per
rispecchiare

le diverse personalità

intimate, comfortable
rooms conceived to reflect
various personalities.

B1



p. 44

B2



p. 52

B3



p. 60

B4



p. 70

B5



p. 80

B6



p. 88

B7



p. 96

B8



p. 104

BI

A
armadio scorrevole
 con anta Profilo in finitura
 nuvola e a specchio, maniglia
 in finitura alluminio.

sliding door wardrobe with Profilo
 door in nuvola finish and mirror, handle in aluminium finish.

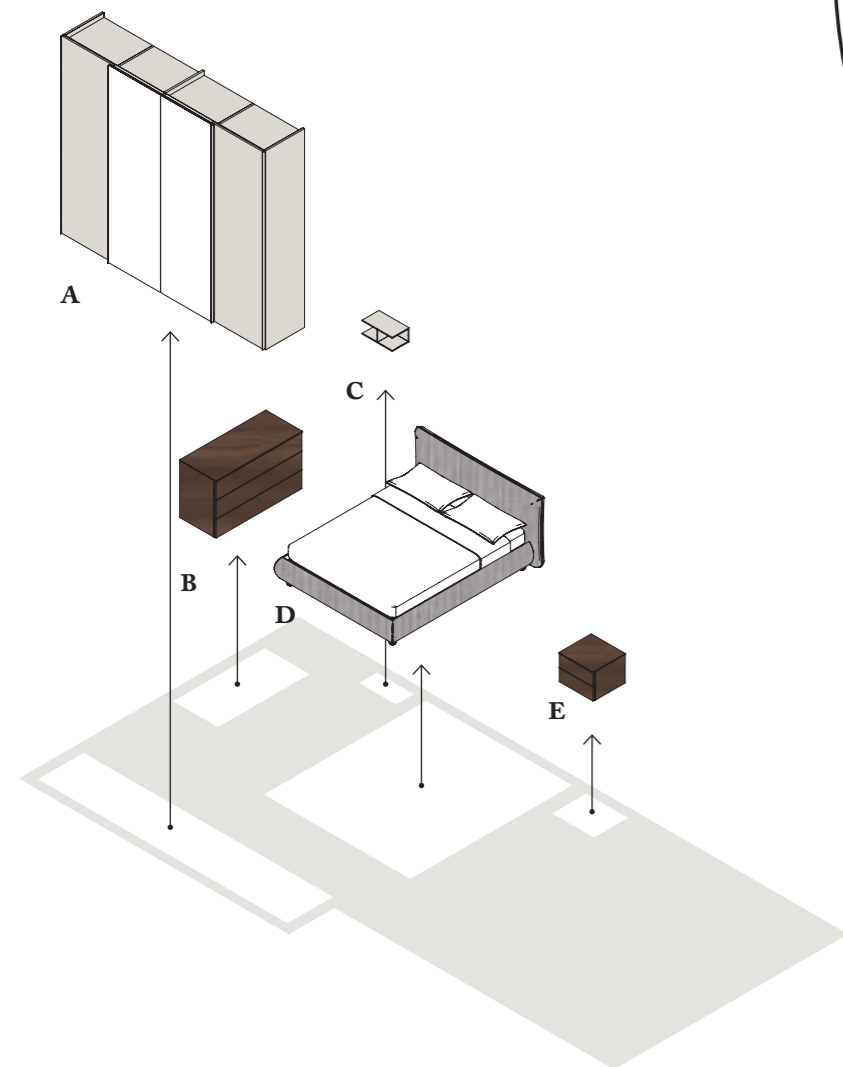

B
comò Atene
 in finitura
 olmo tabacco.

Atene chest of drawers
 in olmo tabacco finish.

C
pensile Zip
 in finitura nuvola.

Zip wall unit in nuvola finish.

D
letto
imbottito Thika
 in tessuto Tex TT17.

Thika padded bed in Tex TT17 fabric.

E
comodino Atene
 in finitura olmo tabacco.

Atene bedside table in olmo tabacco finish.



KEY PRODUCT

**armadio
scorrevole
—
sliding door
wardrobe**

L—W 302,5 H 257,9 P—D 64,2 cm

KEY PRODUCT

BI.1



Armadio scorrevole
con anta Inserto in olmo
shade, maniglia A96 bianca.

Sliding door wardrobe with
Inserto door in olmo shade,
A96 bianco-coloured handle.

BI.2



Armadio scorrevole
con anta Liscia in olmo
tabacco, maniglia A59 brunita.

Sliding door wardrobe with
Plain door in olmo tabacco,
A59 bronze finish handle.

BI.3



Armadio scorrevole con
anta Presa Maxi e maniglia
A91, finitura in basalto.

Sliding door wardrobe with
Presa Maxi door and A91
handle, in basalto finish.

BI.4



Armadio scorrevole
con anta Liscia in cemento,
maniglia A77 in lavagna.

Sliding door wardrobe with
cemento finish Plain door,
A77 lavagna-coloured handle.





comò Atene
—
**Atene chest
of drawers**

L—W 128,7 H 75,9 P—D 54,6 cm



**letto
imbottito Thika**
—
**Thika
padded bed**

L—W 188 H 93,9 P—D 228 cm

B2

A
**armadio anta battente
 e terminale a giorno**
 in finitura cemento,
 maniglia A76, ripiani sagomati
 e pomoli appendiabiti.

wardrobe with hinged doors and open end unit
 in cemento finish, A76 handle, shaped shelves and hanger knobs.

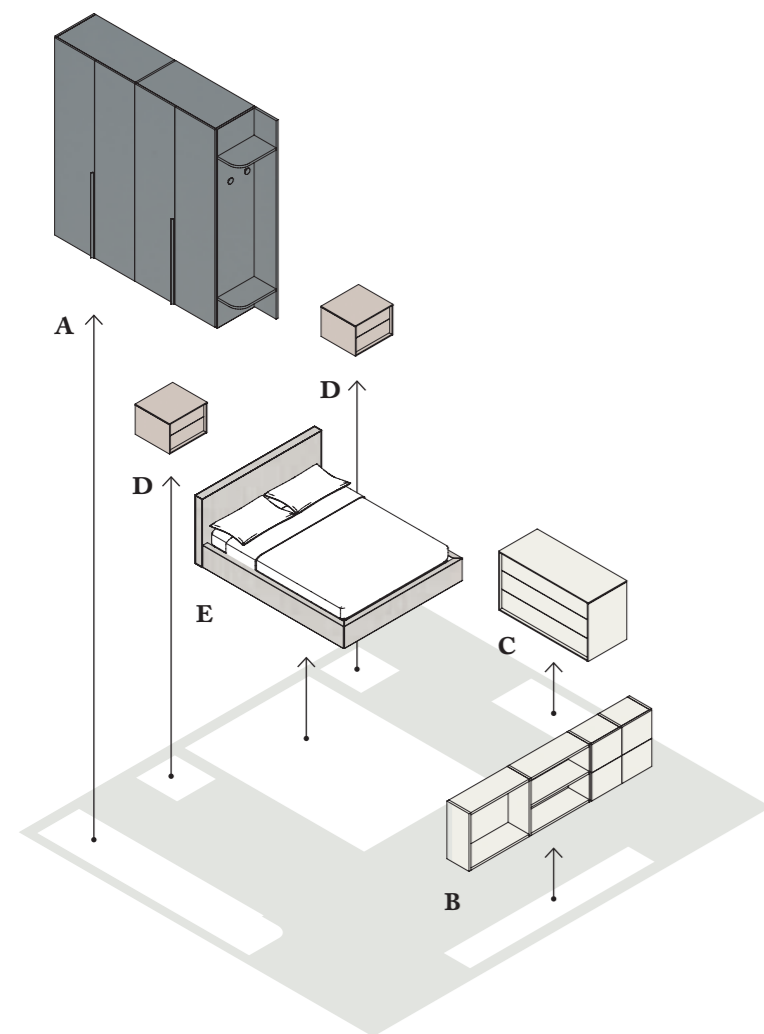

D
comodini Bilbao
 in finitura cashmere.
 Bilbao bedside tables in cashmere finish.

C
comò Bilbao
 in finitura bianco.
 Bilbao chest of drawers in bianco finish.

E
letto imbottito Jerez
 in tessuto Maia TM40.
 Jerez padded bed covered in Maia TM40 fabric.

B
libreria sospesa
 con ante in finitura bianca.
 wall-mounted bookcase with bianco finish doors.

KEY PRODUCT

armadio
 anta battente,
 terminale
 a giorno
 sagomato
 —
 hinged door
 wardrobe,
 shaped
 open end unit

L—W 275,5 H 257,9 P—D 60,6 cm



letto
 imbottito Jerez

—
 Jerez
 padded bed

L—W 180 H 91 P—D 223 cm





KEY PRODUCT

B2.1



Armadio anta battente
in basalto, maniglia
Inserto brunita, **terminale**
a giorno in basalto con
schiena in olmo tabacco.

Basalto-coloured **hinged**
door wardrobe, bronze
finish Inserto handle,
basalto-coloured **open**
end unit with olmo
tabacco finish back panel.

B2.2



Armadio anta battente
in sabbia, maniglia A52
olmo nordico, **terminale**
a giorno sagomato in sabbia,
ripiani in olmo nordico.

Sabbia-coloured **hinged**
door wardrobe, olmo
nordico finish A52 handle,
sabbia-coloured **shaped**
open end unit, olmo
nordico finish shelves.

B2.3



Armadio anta battente
e terminale trapezio
in olmo shade, maniglia
bianca per anta Piega.

Wardrobe with trapezium
end unit and Piega door
in olmo shade finish,
bianco-coloured handle.

B2.4



Armadio anta battente
Presa Maxi in cashmere,
maniglia A92 in olmo tabacco,
terminale libreria senza
schiena in olmo tabacco.

Wardrobe with Presa Maxi
hinged doors in cashmere
finish, olmo tabacco A92
handle, **open end unit** in olmo
tabacco with no back panel.



comò Bilbao
—
**Bilbao chest
of drawers**

L—W 134,3 H 77 P—D 57,8 cm



**libreria a spalla
sospesa con ante**
—
**wall-mounted
bookcase
with doors**

L—W 273 H 74,7 P—D 35,2 cm

B3

A
armadio anta battente Presa Maxi, angolo spogliatoio P03 e terminale trapezio
 in finitura bianco,
 maniglia A91L.

Presa Maxi hinged door wardrobe, P03 corner walk-in closet and trapezium end unit in bianco finish, A91L handle.

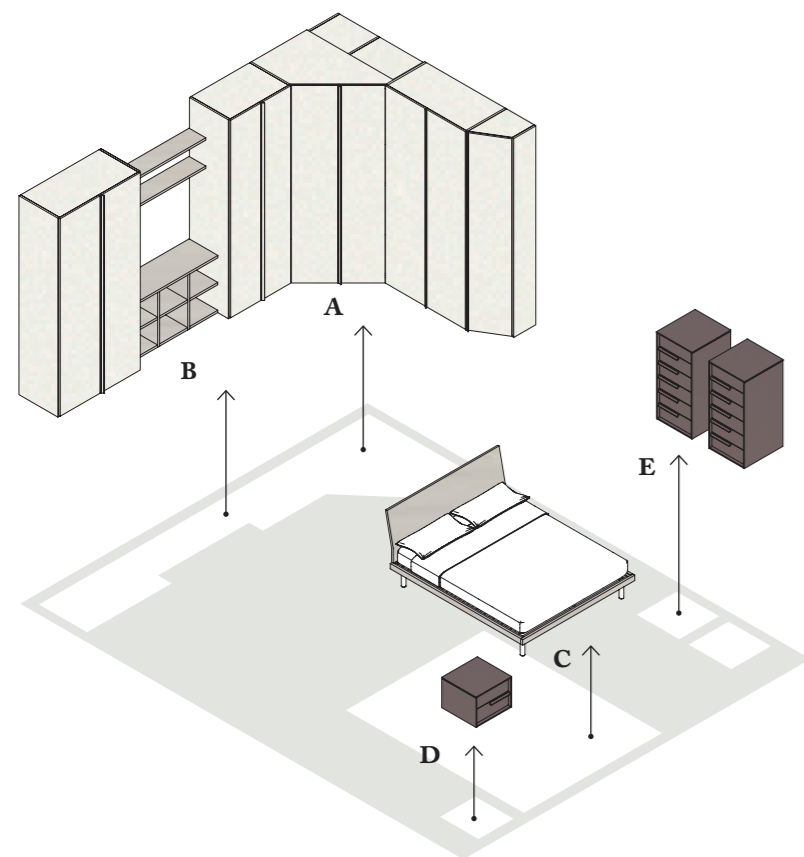

B
libreria a terra e mensole
 in finitura olmo nordico.

floorstanding bookcase
 and shelves in olmo nordico finish.

C
letto Thun
 in finitura olmo nordico.

Thun bed in olmo nordico finish.

D
comodino Bonn
 in finitura castoro.

Bonn bedside table in castoro finish.

E
settimini Bonn
 in finitura castoro.

Bonn tallboys in castoro finish.



KEY PRODUCT

**composizione
armadio anta
battente
con angolo
spogliatoio e
terminale trapezio**

—
**hinged door
wardrobe
composition
with corner
walk-in closet
and trapezium
end unit**

libreria
—
bookcase

L—W 132 H 77,9 P—D 43 cm



KEY PRODUCT

B3.1



Moduli armadio con anta Presa Maxi battente, maniglia A91L e **libreria a spalla** senza schiena in finitura lavagna, **terminale a giorno** in finitura lavagna, con schiena in olmo nordico.

Presa Maxi hinged door wardrobe modules, A91L handle, **bookcase** with no back panel in lavagna finish. Lavagna-coloured **open end unit** with olmo nordico back panel.

B3.2



Libreria a spalla a terra e sospesa in basalto. **Armadi anta battente e angolo spogliatoio P07** con anta Presa Maxi in finitura olmo shade, maniglia A91 in olmo tabacco.

Basalto-coloured **floorstanding and wall-mounted bookcase**. **Olmo shade-coloured hinged door wardrobes and P07 corner walk-in closet** with Presa Maxi doors, A91 handle in olmo tabacco finish.



letto Thun
—
Thun bed

L—W 1683 H 95 P—D 206 cm

**settimini
e comodino
Bonn**
—
**Bonn
tallboys and
bedside table**

L—W 53,3 H 113,7 P—D 57,8 cm
L—W 53,3 H 40,5 P—D 51,4 cm

B4

A
cabina armadio e chiusura scorrevole interno in finitura nuvola, ante scorrevoli in finitura cemento con telaio brunito.

walk-in wardrobe and sliding door closing system with nuvola finish interior, cemento finish sliding doors whit bronze finish frame.

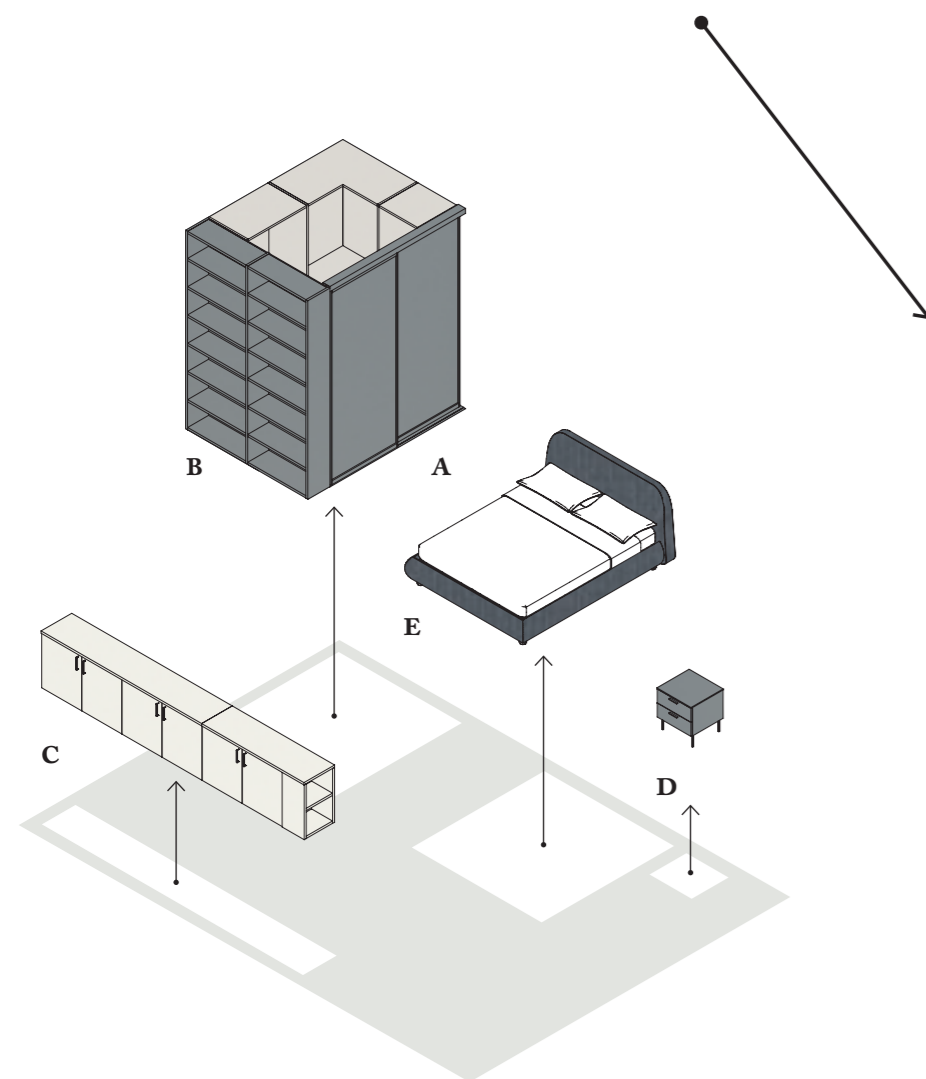

B
libreria a terra
 in finitura cemento.

floorstanding bookcase in cemento finish.

C
contenitori base e modulo libreria
 in finitura bianco, maniglia A57.

base storage units and bookcase module in bianco finish, A57 handle.

D
comodino Praga
 in finitura cemento.

Praga bedside table in cemento finish.

E
letto imbottito Kora
 in tessuto Maia TM10

Kora padded bed covered in Maia TM10 fabric.

KEY PRODUCT

**cabina armadio
—
walk-in wardrobe**

L—W 202,3 H 257,9 P—D 172,3 cm

**letto
imbottito
Kora
—
Kora
padded bed**

L—W 184 H 97 P—D 226 cm



**libreria
a terra
—
floorstanding
bookcase**

L—W 183 H 257,9 P—D 33 cm



KEY PRODUCT

B4.1



Moduli cabina in nuvola, **libreria a spalla** in finitura lavagna, **chiusura dritta con ante Gola battenti**, in finitura lavagna.

Nuvola-coloured **walk-in wardrobe modules**, lavagna-coloured **bookcase**, **straight closing system with Gola hinged doors** in lavagna finish.

B4.2



Moduli cabina in nuvola, **libreria a spalla** in olmo nordico, **chiusura dritta con ante Inserto battenti e pieghevoli** in olmo nordico, maniglia A96 bianco.

Nuvola-coloured **walk-in wardrobe modules**, olmo nordico **bookcase**, **straight closing system with Inserto hinged and folding doors** in olmo nordico finish, A96 bianco-coloured handle.

**contenitori
base e modulo
libreria a terra
—
base storage
units and
floorstanding
bookcase module**

L—W 393,2 H 77,9 P—D 45,8 cm



**comodino
Praga
—
Praga
bedside table**

L—W 51 H 54,8 P—D 48,2 cm

B5

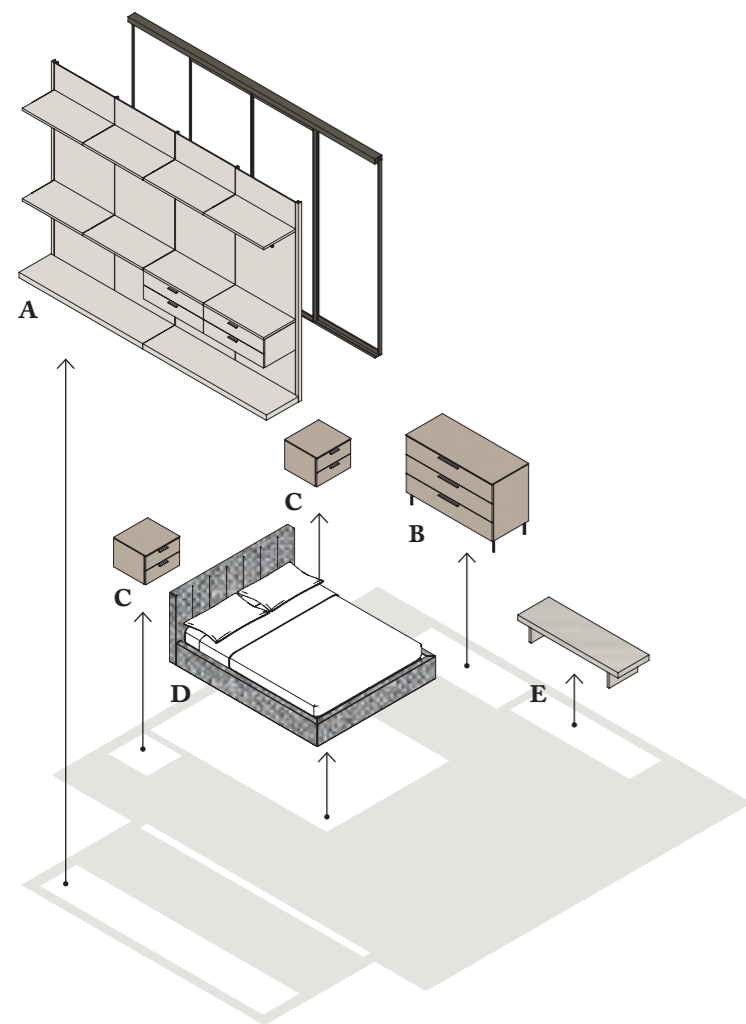

A
cabina Rio e
chiusura scorrevole
 in finitura nuvola e grigio,
 ante scorrevoli fumè
 con telaio brunito.

Rio walk-in wardrobe and sliding door closing system
 in nuvola and grigio finish, smoked glass sliding doors
 and bronze finish frame.

B
comò Praga
 in finitura sabbia.

Praga chest of drawers in sabbia finish.

C
comodini Oslo
 in finitura sabbia.

Oslo bedside tables in sabbia finish.

E
panca
 in finitura
 olmo nordico.

bench in olmo nordico finish.

D
letto imbottito York
 in tessuto Charlie TC06.

York padded bed covered in Charlie TC06 fabric.



KEY PRODUCT

cabina Rio
—
Rio
walk-in wardrobe

L—W 369,5 H 257,9 P—D 52,8 cm



KEY PRODUCT

B5.1



Cabina Rio con schiena e panche in finitura sabbia, cassettiere e ripiani in olmo tabacco, maniglie brunite.

Rio walk-in wardrobe with sabbia finish back panel and benches, olmo tabacco finish drawer units and shelves, bronze finish handles.

B5.2



Cabina Rio con schiena e panche in olmo nordico, cassettiere in olmo nordico e maniglie bianche, ripiani in castoro.

Rio walk-in wardrobe with olmo nordico back panel and benches, olmo nordico drawer units and bianco-coloured handles, castoro-coloured shelves.

comodino Oslo
—
Oslo
bedside table

L—W 51 H 39,3 P—D 48,2 cm

letto
imbottito York
—
York
padded bed

L—W 178 H 92 P—D 222 cm

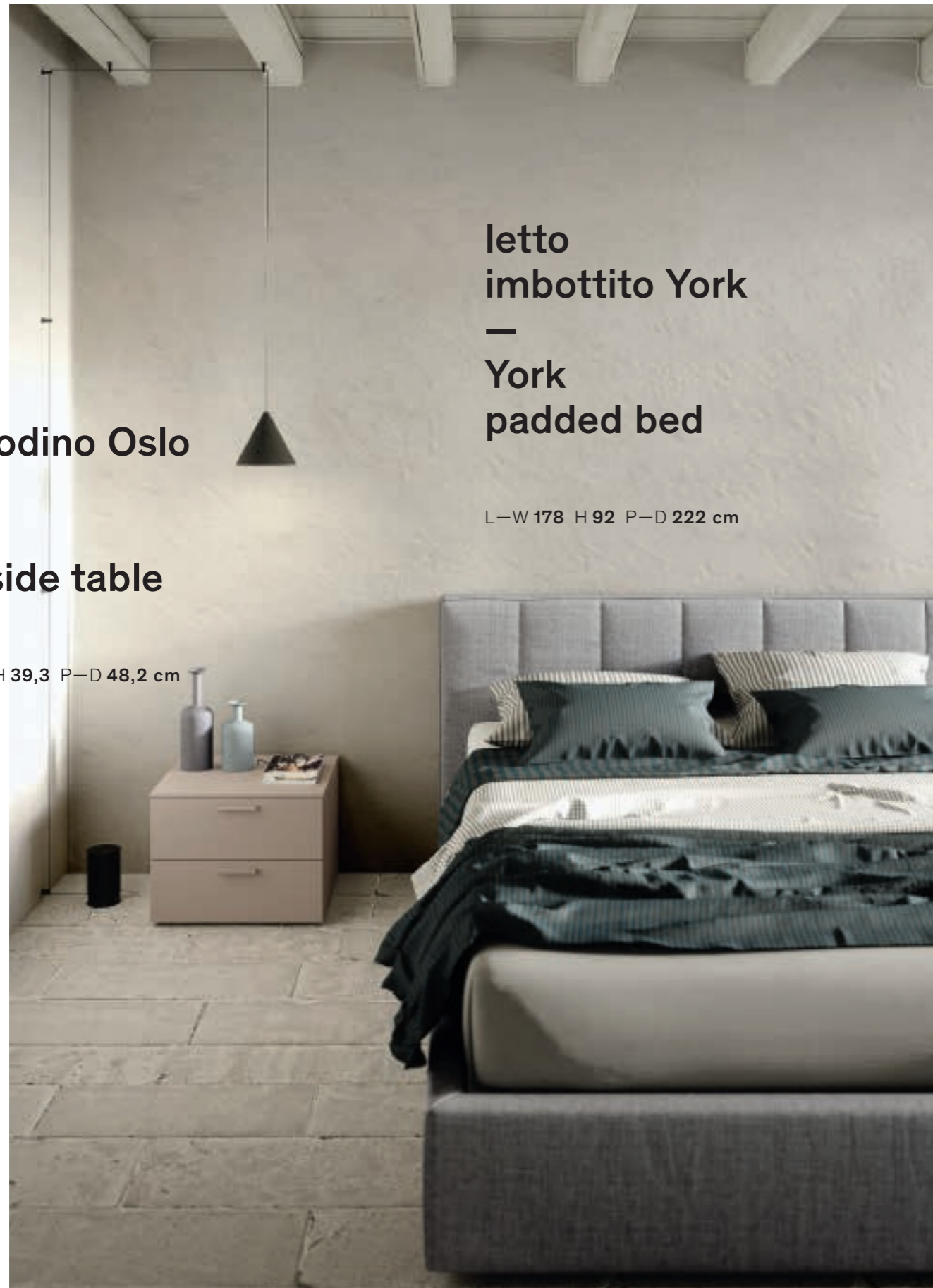

comò Praga
—
Praga chest
of drawers

L—W 128,7 H 91,4 P—D 54,6 cm

B6

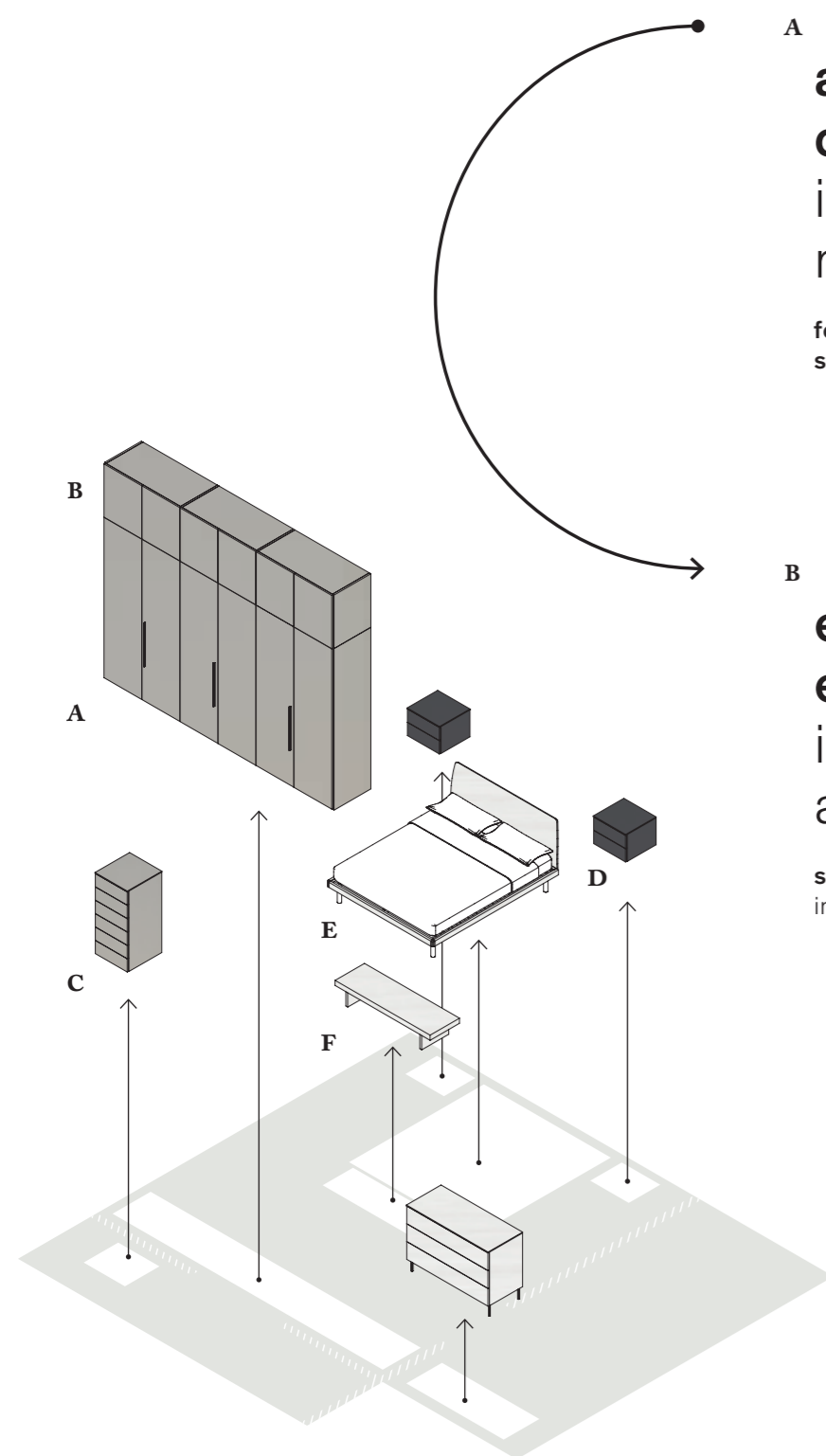

A
**armadio e chiusura
 con anta pieghevole,**
 in finitura grigio,
 maniglia A70.

**folding door wardrobe and closing
 system** in grigio finish, A70 handle.

B
**elementi sovrapponibili
 ed elemento a ponte**
 in finitura grigio,
 apertura push-pull.

stackable units and bridging unit
 in grigio finish, push-to-open mechanism.



E
letto Gabes
 in finitura olmo shade.

Gabes bed in olmo shade finish.

D
comodini Oslo
 in finitura lavagna.

Oslo bedside tables in lavagna finish.

F
panca
 in finitura olmo shade.

bench in olmo shade finish.

C
settimino Oslo
 in finitura grigio.

Oslo tallboy in grigio finish.

KEY PRODUCT

**armadio e chiusura
anta pieghevole,
elementi
sovrapponibili
ed elemento ponte**

—
**folding door
wardrobe and
closing system,
stackable units
and bridging unit**

L—W 362,5 H 294,5 P—D 60,6 cm



KEY PRODUCT

B6.1



Allestimento armadio con ripiani, cassettiere 3 e 5 cassetti, divisori fianco cassetiera in nuvola, tubi e servetto appendiabiti, scarpiera, cesto laterale e attrezzatura estraibile in alluminio.

Wardrobe arrangement with shelves, drawer units with 3 and 5 drawers, nuvola-finish drawer unit side partitions, hanging rails and clothes lift, shoe rack, side basket and pull-out fittings in aluminium.

B6.2



Allestimento armadio a giorno con ripiani, cassettiere 3 e 5 cassetti, divisori fianco cassetiera e crociera in nuvola, tubi appendiabiti in alluminio.

Open wardrobe arrangement with shelves, drawer units with 3 and 5 drawers, nuvola-finish drawer unit side partitions and pigeon holes, aluminium hanging rails.

settimino Oslo
—
Oslo tallboy

L—W 51 H 112,5 P—D 54,6 cm



letto Gabes
—
Gabes bed

L—W 168 H 95 P—D 206 cm

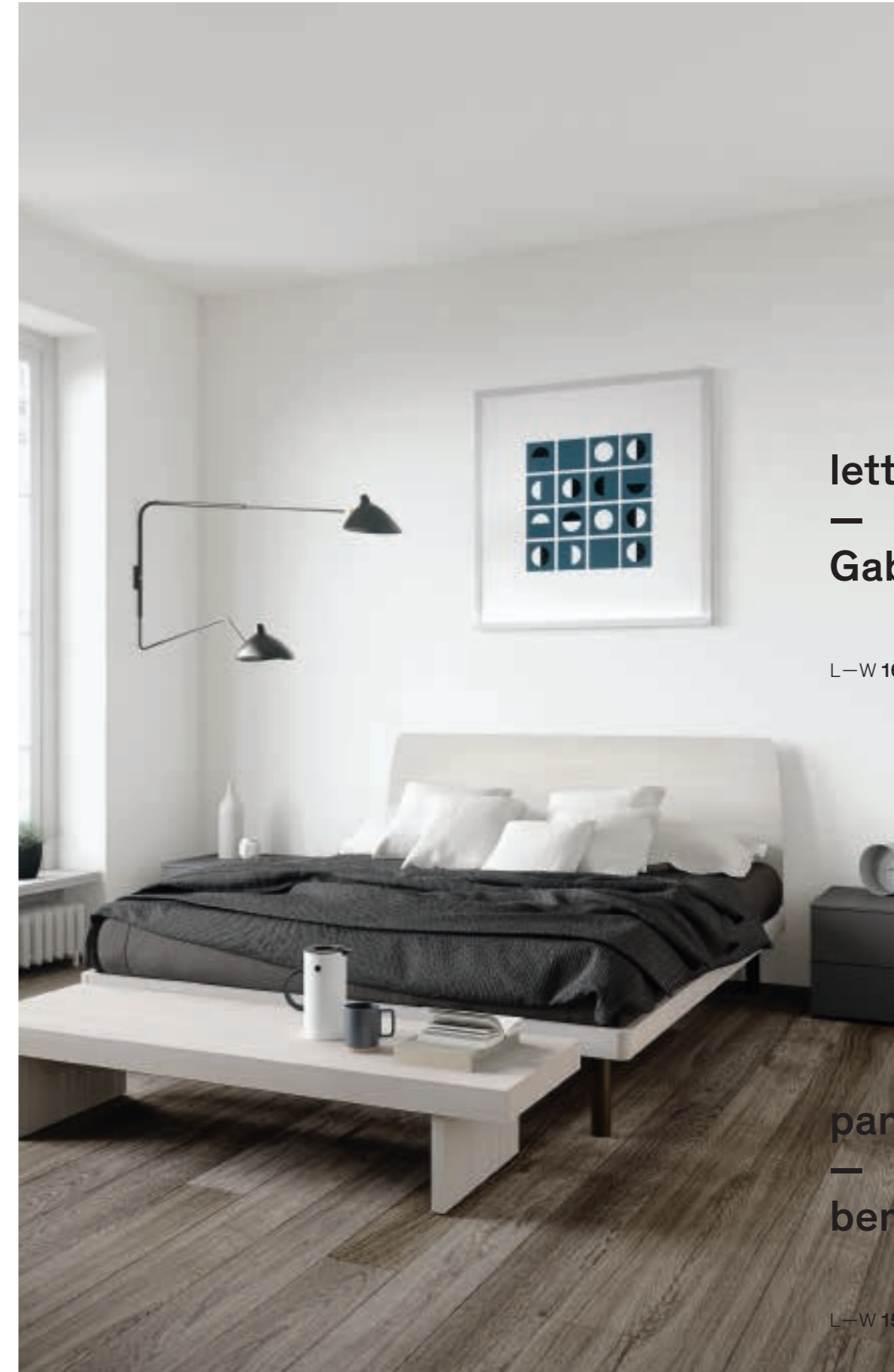

panca
—
bench

L—W 150 H 29 P—D 46,4 cm

B7

A
elemento a ponte
 in finitura nuvola.
 bridging unit in nuvola finish.

B
armadi anta
battente
 in finitura nuvola.
 hinged door wardrobes in nuvola finish.

C
libreria a terra
 in finitura grigio.
 floorstanding bookcase in grigio finish.

F
comò Londra
 in finitura canapa.
 Londra chest of drawers in canapa finish.

E
letto Este
 in finitura grigio.
 Este bed in grigio finish.

D
libreria sospesa
 in finitura nuvola.
 wall-mounted bookcase in nuvola finish.

G
tavolo Leone in finitura
bianco, sedie Sneek in
finitura nero
con base R1.
 bianco coloured Leone table, black finish
 Sneek chairs with R1 base.

H
libreria
sospesa e a terra
 in finitura nuvola.
 wall-mounted and floorstanding
 bookcase in nuvola finish.

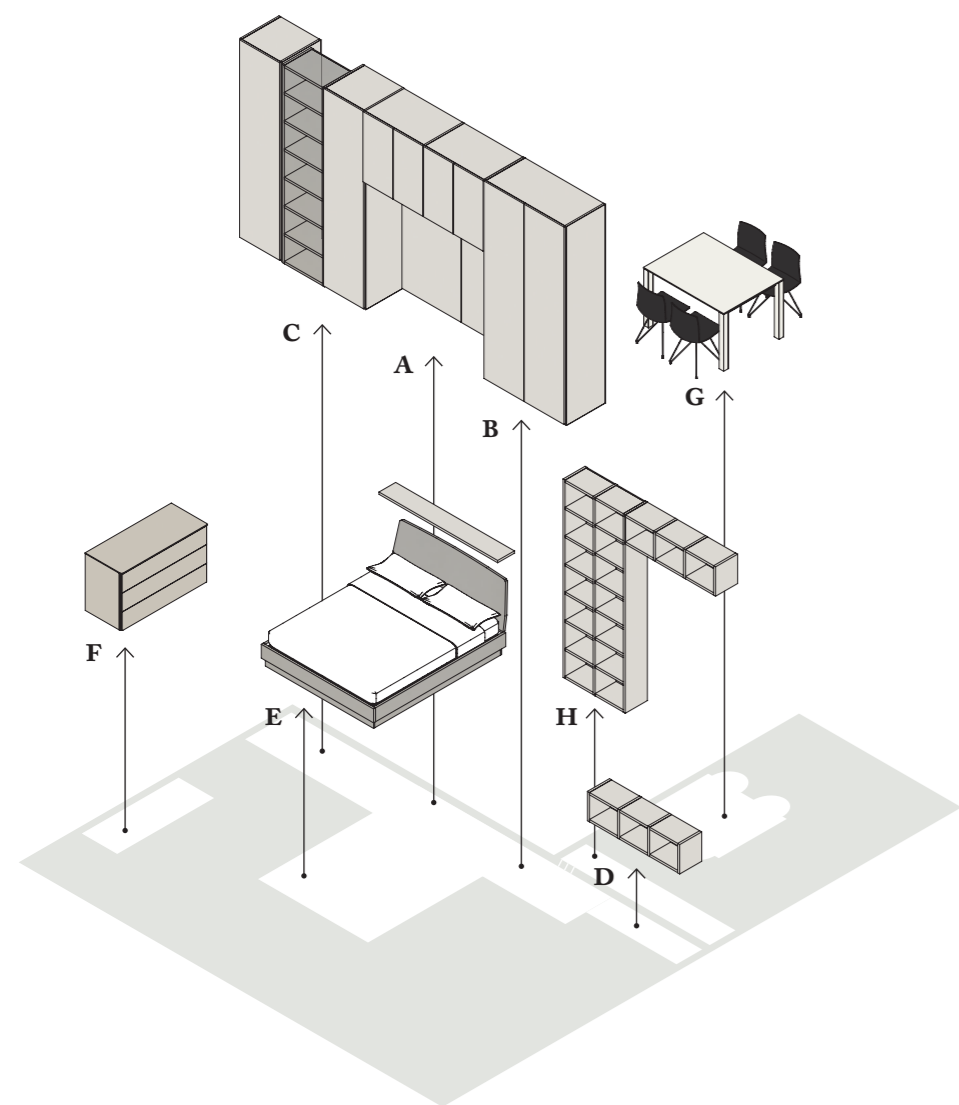

KEY PRODUCT

elemento a ponte, libreria a terra, armadi anta battente

— bridging unit, floorstanding bookcase, hinged door wardrobes

L—W 488 H 257,9 P—D 60,6 cm



letto Este
— Este bed

L—W 168 H 95 P—D 167,5 cm



KEY PRODUCT

B7.1



Armadi anta battente in basalto, maniglia A67 brunita, **libreria a ponte** in basalto con schiena in olmo nordico, **letto Este** in finitura lavagna con rete alzante.

Basalto-coloured **hinged door wardrobes**, bronze finish A67 handle, basalto-coloured **bridging unit** with olmo nordico finish back panel, lavagna-coloured **Este bed** with lift-up mattress base.

B7.2



Armadi battenti con anta Gola in finitura cashmere, **libreria a spalla** in cashmere con schiena in olmo tabacco, **letto ribaltabile** in cashmere con schiena in olmo tabacco e cashmere, maniglia A52 in olmo tabacco.

Cashmere-coloured **hinged Gola door wardrobes**, cashmere-coloured **bookcase** with olmo tabacco finish back panel, cashmere-coloured **fold-down bed** with olmo tabacco and cashmere finish back panel, olmo tabacco finish A52 handle.

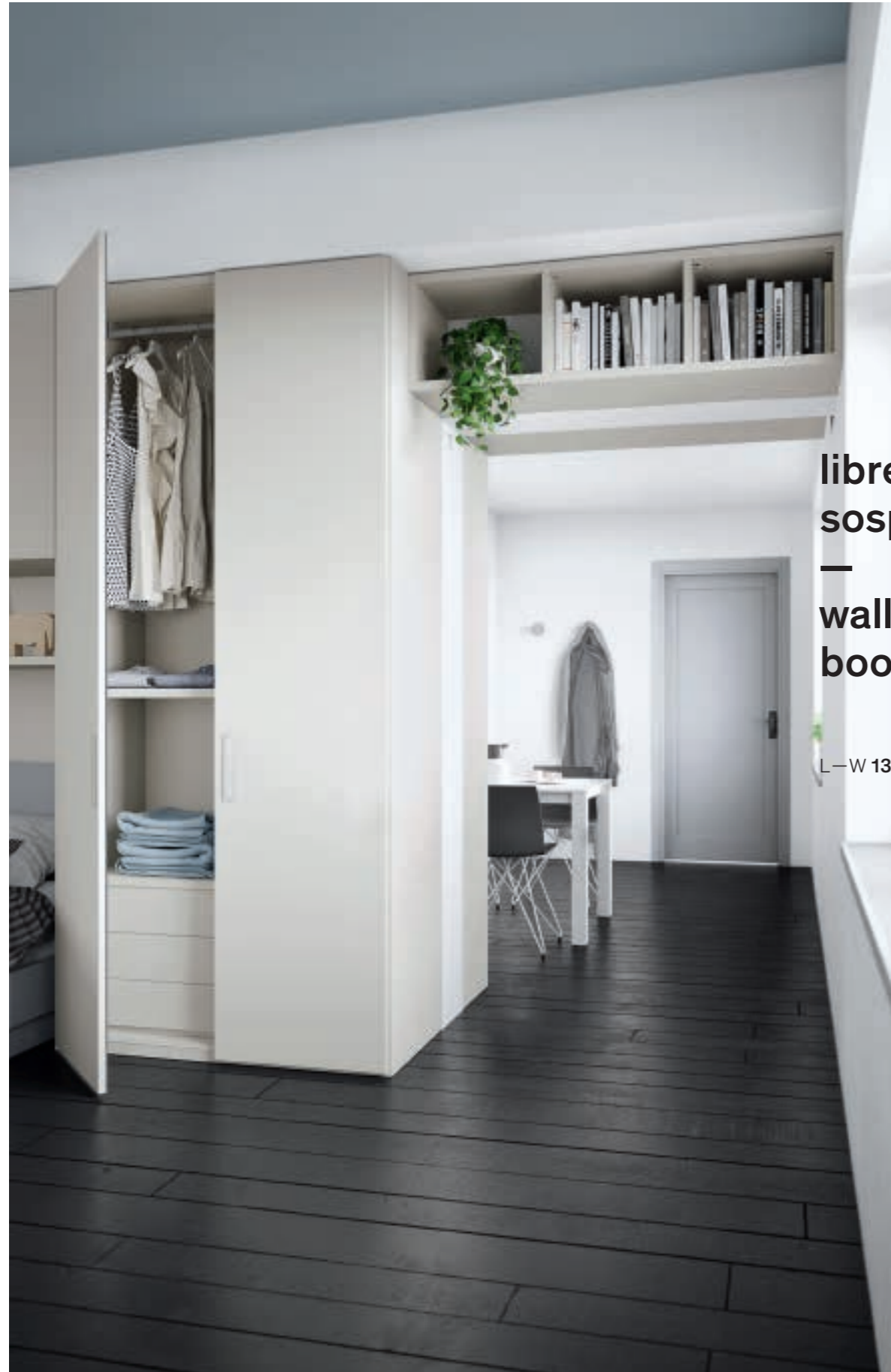

**libreria
sospesa**
—
**wall-mounted
bookcase**

L—W 138 H 38,1 P—D 33 cm

**libreria
sospesa e a terra**
—
**wall-mounted
and floorstanding
bookcase**

L—W 228 H 257,9 P—D 33 cm



B8

A
**armadi anta battente
 ed elemento a ponte**
 in finitura olmo nordico
 con maniglia A54.

hinged door wardrobes and bridging unit
 in olmo nordico finish with A54 handle.



B
cabina Rio
 in finitura
 olmo nordico.

Rio walk-in wardrobe
 in olmo nordico finish.



C
piano scrittoio
 in finitura bianco.

desk in bianco finish.



F
**libreria
 a spalla bifacciale**
 in finitura bianco.

double-sided bookcase in bianco finish.

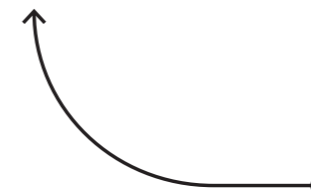

E
divano letto
 in tessuto Tex TT10.

Sofa bed covered in Tex TT10 fabric.

D
letto imbottito Jerez
 in tessuto Maia TM28.

Jerez padded bed covered in Maia TM28 fabric.

G
settimini Bilbao
 in finitura bianco.

Bilbao tallboys in bianco finish.

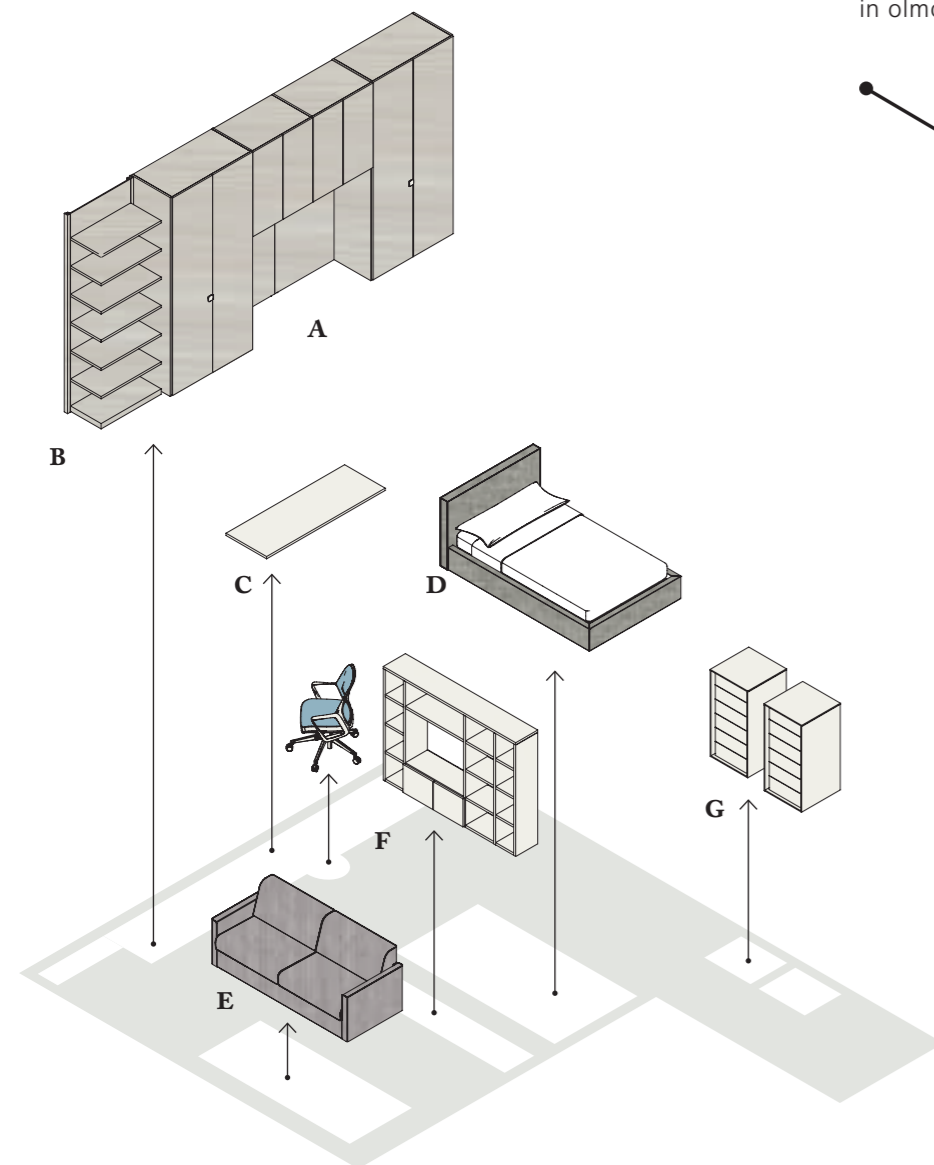

**libreria a spalla
bifacciale**
—
**double-sided
bookcase**

L—W 198 H 148,1 P—D 35,2 cm

**letto
imbottito Jerez**
—
**Jerez
padded bed**

L—W 140 H 91 P—D 223 cm

KEY PRODUCT

**armadi
anta battente
ed elemento
a ponte**
—
**hinged door
wardrobes
and bridging unit**

L—W 422,5 H 257,9 P—D 60,6 cm





scrivania
—
desk

L—W 177,4 H 73 P—D 54,9 cm

sedia Vichy
—
Vichy chair

L—W 82,6 H 100,1 P—D 82,1 cm

KEY PRODUCT

B8.1



Armadi anta battente
ed elemento a ponte
in nuvola, maniglia
A53 brunita, **pannello**
sottoponte in olmo
tabacco, **divano letto** in Tex
TT10 con fettuccia ruggine.

Nuvola finish **hinged door**
wardrobes and bridging
unit, bronze finish A53 handle,
olmo tabacco finish **panel**
under bridging unit, sofa bed
covered in Tex TT10 fabric
with rust-coloured piping.

cabina Rio
—
Rio
walk-in wardrobe

L—W 98,8 H 257,9 P—D 50,8 cm



settimini Bilbao
—
Bilbao tallboys

L—W 56,1 H 113,7 P—D 57,8 cm



**ambienti
domestici**

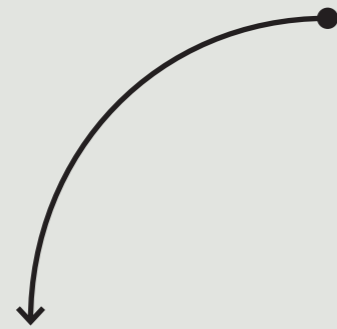

multifunzionali

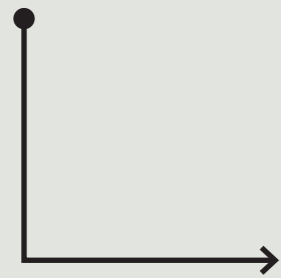

**organizzati
per garantire**



**praticità
e ordine**

multi-functional rooms
organised to ensure
practicality and order.

U1



p. 114

U2



p. 120

U3



p. 128

UI

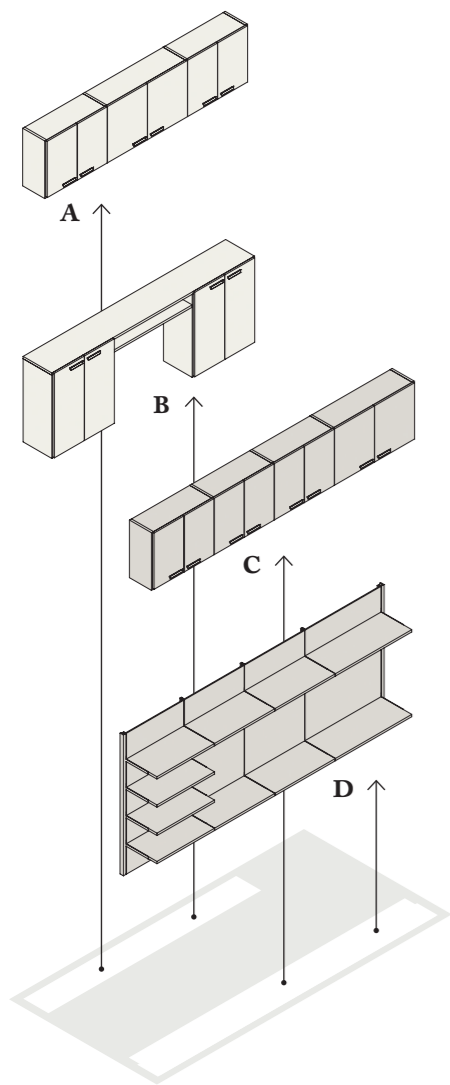

A
**libreria
 sospesa con ante**
 in finitura bianco,
 maniglia A60.

wall-mounted bookcase with
 bianco finish doors, A60 handle.

B
**libreria
 a terra con ante**
 in finitura bianco,
 maniglia A60.

floorstanding bookcase with
 bianco finish doors, A60 handle.

C
**libreria
 sospesa con ante**
 in finitura nuvola,
 maniglia A60.

wall-mounted bookcase
 with nuvola finish doors, A60 handle.

D
cabina Rio
 in finitura nuvola.

Rio walk-in wardrobe in nuvola finish.

KEY PRODUCT

cabina Rio
—
Rio
walk-in wardrobe

L—W 393 H 182,5 P—D 50,8 cm



KEY PRODUCT

libreria
a terra con ante
—
floorstanding
bookcase
with doors

L—W 303 H 115 P—D 45,2 cm



KEY PRODUCT

UI.1



Pensili e basi sospese
in finitura cashmere con
pomolo A54 brunito,
casellari Zip in olmo tabacco.

**Wall units and wall-mounted
base units** in cashmere finish
with bronze finish A54 handle,
olmo tabacco finish **Zip open
wall units**.

UI.2



**Pensili, casellari,
basi a terra e basi
in appoggio a giorno,**
maniglia A68 in nuvola.

**Wall units, open wall units,
floorstanding base units and
open sit-on-top base units,**
A68 handle in nuvola finish.

UI.3



Libreria a spalla a terra con
e senza schiena in lavagna,
ante in olmo shade con
maniglie A59 e A67 bianche.

Lavagna-coloured
floorstanding bookcase
with and without a back
panel, olmo shade doors
with bianco-coloured
A59 and A67 handles.

UI.4

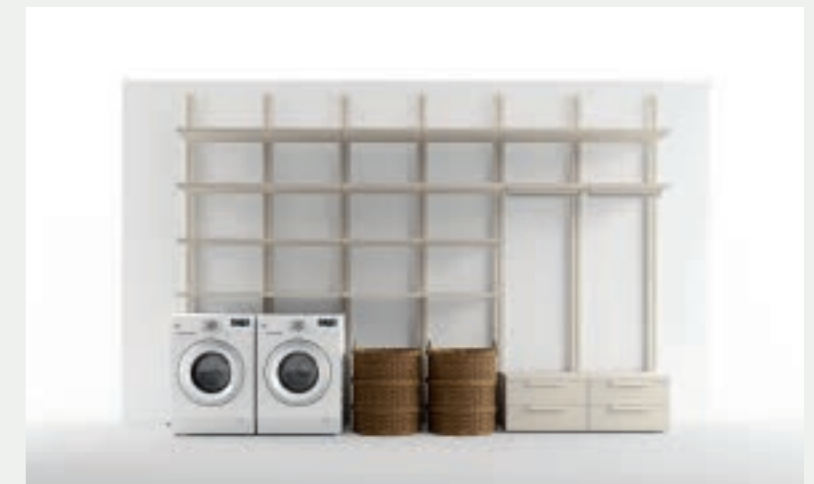

Cabina Rio senza
schiena in olmo nordico,
ripiani e cassettiere con
maniglia A74 in olmo nordico.

Rio walk-in wardrobe
in olmo nordico finish with
no back panel, olmo nordico
finish shelves and drawer
units with A74 handle.

U2

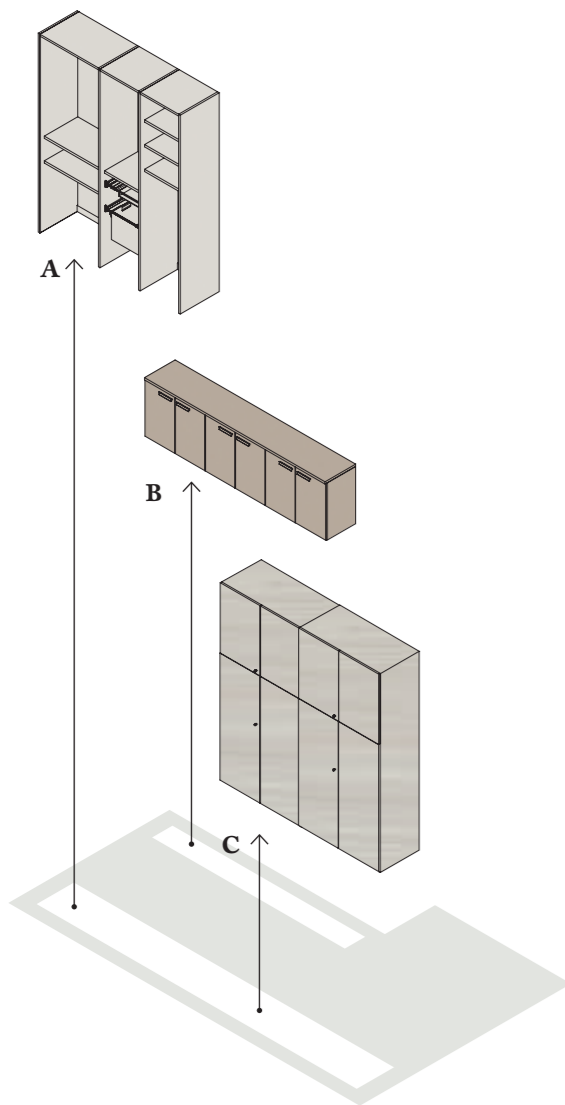

A
**composizione
 armadio a giorno
 senza base**
 in finitura nuvola.

open wardrobe composition
 without base in nuvola finish.



B
basi a terra
 in finitura sabbia
 con maniglia A60.

floorstanding base units
 in sabbia finish with A60 handle.



C
**armadio anta
 battente ed elementi
 sovrapponibili**
 in finitura olmo
 nordico con serratura.

hinged door wardrobes and stackable units
 in olmo nordico finish with lock.



KEY PRODUCT

basi a terra
—
**floorstanding
base units**

L—W 270 H 77,9 P—D 45,8 cm



KEY PRODUCT

U2.1



Basi a terra con modulo ad angolo con cambio di profondità in lavagna, pomolo A53 bianco.

Floorstanding base units and corner module with different depths in lavagna finish, bianco-coloured A53 handle.

U2.2



Basi a terra con vano a giorno in nuvola, maniglia A40 bianca.

Nuvola-coloured **floorstanding base units** with **open shelving**, bianco-coloured A40 handle.

U2.3



Basi sospese in finitura cashmere con maniglia A47 brunita.

Wall-mounted base units in cashmere finish with bronze finish A47 handle.

U2.4



Basi sospese con vani a giorno in nuvola, olmo nordico e basalto con apertura push-pull.

Wall-mounted base units with open shelving in nuvola, olmo nordico and basalto finishes, push-to-open mechanism.



**composizione
armadio a giorno
—
open wardrobe
composition**

L—W 210 H 257,9 P—D 58,2 cm



U3

A
**composizione
 armadio a giorno**
 in finitura nuvola.
 open wardrobe composition in nuvola finish.

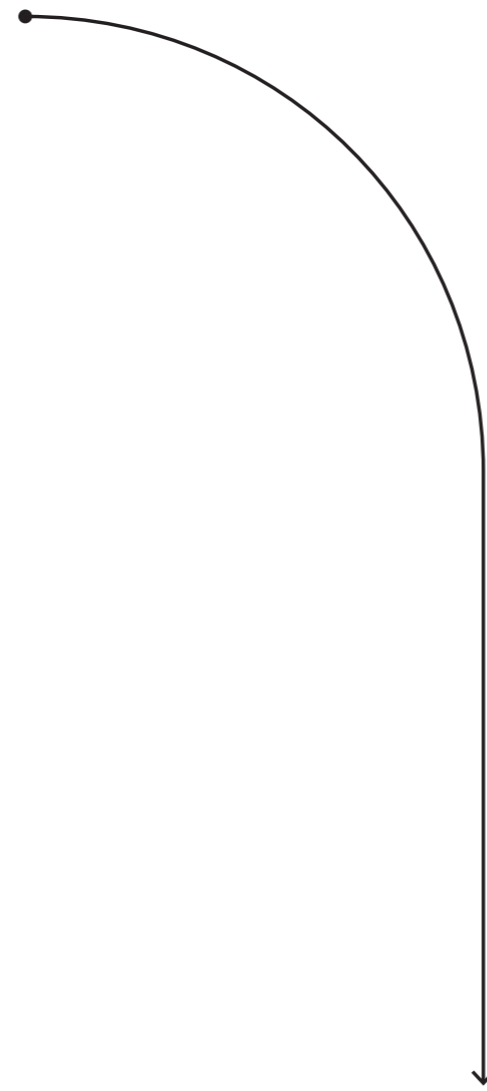
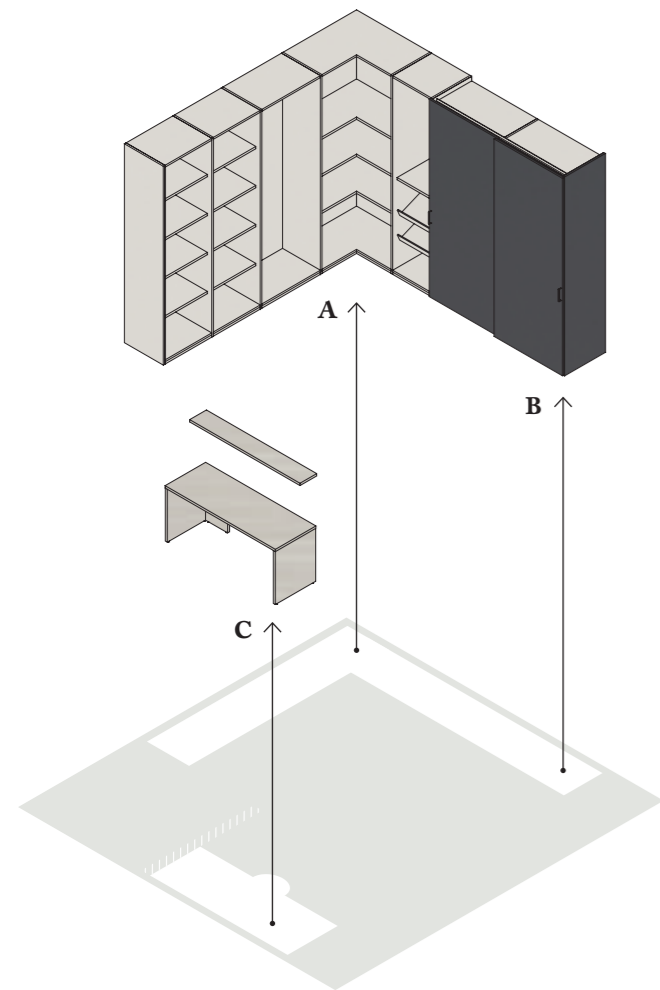

B
armadio scorrevole
 in finitura lavagna,
 maniglia A57.
 sliding door wardrobe
 in lavagna finish, A57 handle.

C
scrivania e mensola
 in finitura olmo nordico.
 desk and shelf in olmo nordico finish.

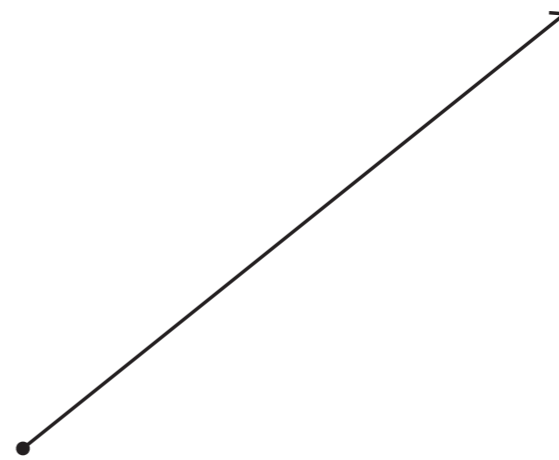

KEY PRODUCT

**composizione
armadio a giorno
—
open wardrobe
composition**



KEY PRODUCT

U3.1



Moduli cabina armadio
con e senza base in nuvola,
armadio Light con maniglia
A62 in nuvola.

Walk-in wardrobe modules
with and without base in
nuvola, **Light wardrobe** with
nuvola-coloured A62 handle.

U3.2



Cabina Rio in finitura lavagna.

Lavagna-coloured
Rio walk-in wardrobe.



**scrivania
e mensole**
—
desk and shelf

L-W 165 H 73 P-D 60,3 cm
L-W 165 H 3 P-D 25 cm



**elementi
personalizzabili**

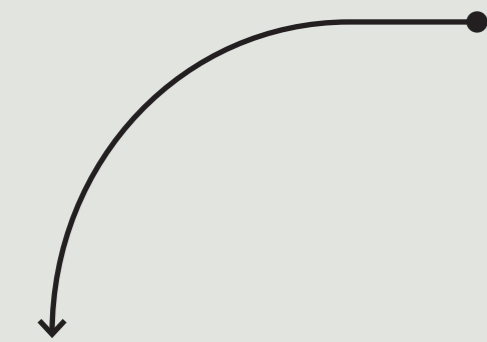

**per colore, forma,
e dimensioni**

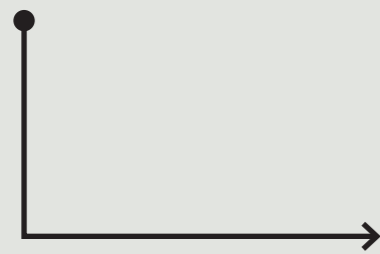

**capaci
di caratterizzare**



ogni spazio

the colour, shape
and dimensions
of our furniture can
be customised to
personalise any space.

MATERIALI

—
MATERIALS

p. 138

MANIGLIE

—
HANDLES

p. 142

LETTI

—
BEDS

p. 146

COMÒ, COMODINI
E SETTIMINI

—
CHESTS OF DRAWERS,
BEDSIDE TABLES
AND TALLBOYS

p. 154

ATTREZZATURE
PER ARMADI E CABINE

—
WARDROBE
AND WALK-IN WARDROBE FITTINGS

p. 158

MATERIALI — *finiture*

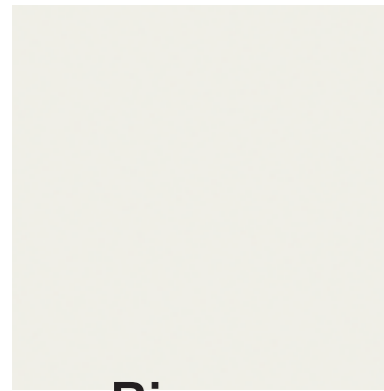

Bianco

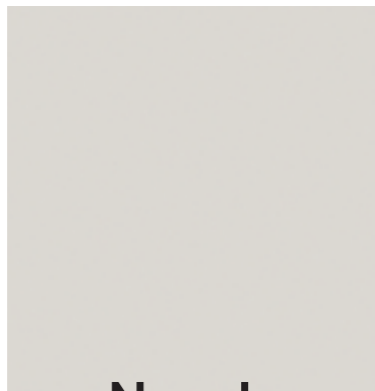

Nuvola

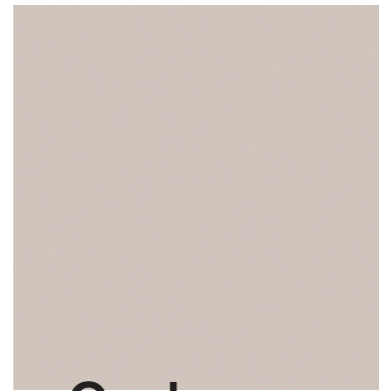

Cashmere

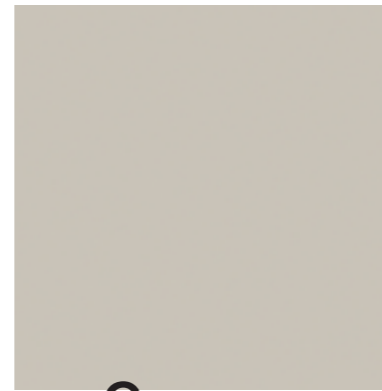

Canapa

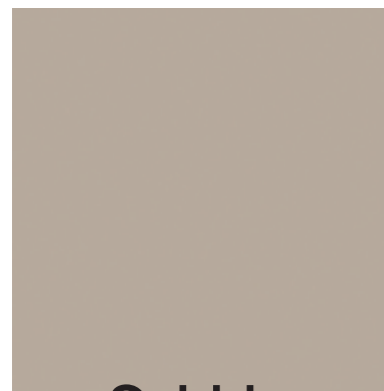

Sabbia

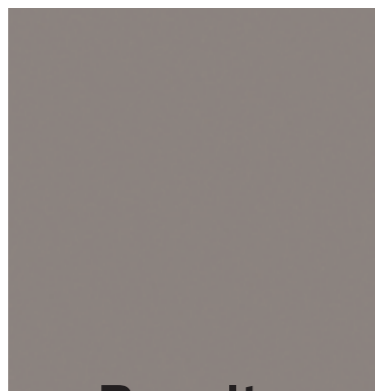

Basalto



Castoro

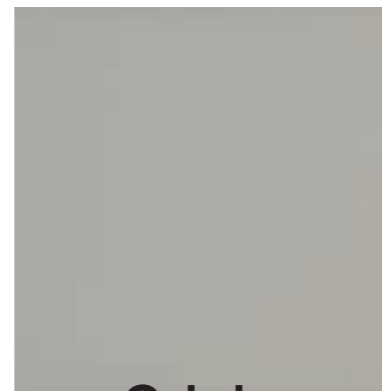

Grigio



Cemento



Lavagna

MATERIALS — *finishes*

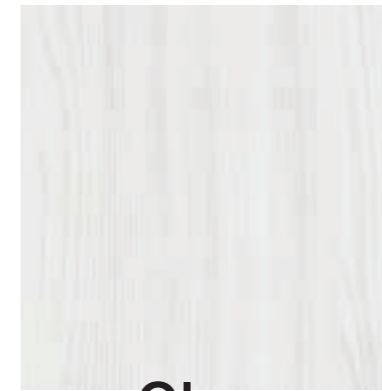

**Olmo
shade**

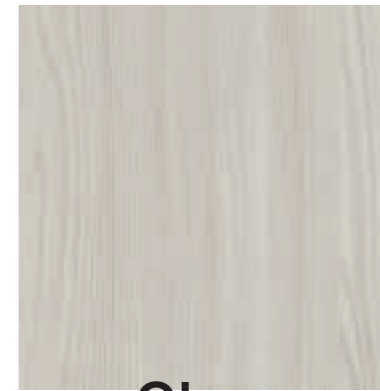

**Olmo
nordico**

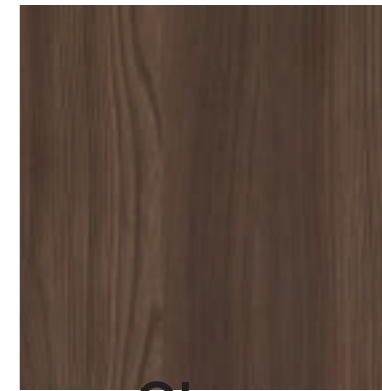

**Olmo
tabacco**

MATERIALI — tessuti

Maia

tessuto/fabric

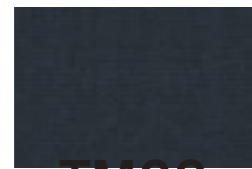

TM06



TM08



TM10



TM13



TM15



TM16

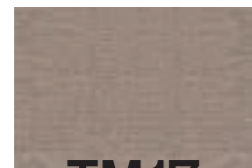

TM17



TM23

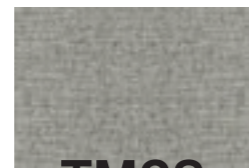

TM28

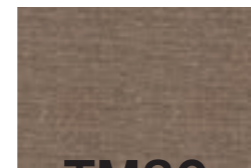

TM30



TM40



TM42



TM45

Tex

tessuto/fabric



TT01



TT03



TT06



TT10



TT12



TT16



TT17



TT18



TT30

Charlie

tessuto/fabric



TC06

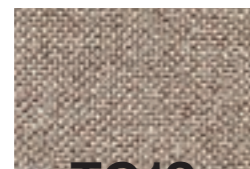

TC12

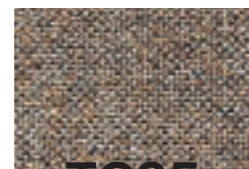

TC25



TC39

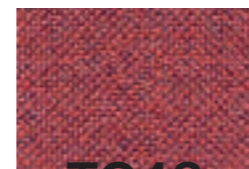

TC43

MATERIALS — fabrics

Slim

ecopelle/
imitation leather

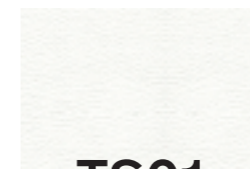

TS01



TS06



TS07



TS09



TS11

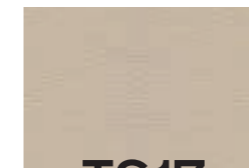

TS17

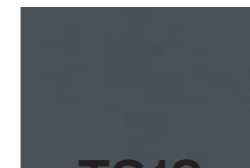

TS18

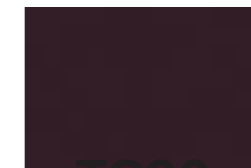

TS20

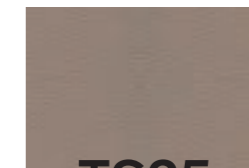

TS25

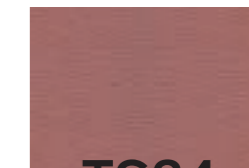

TS34



TS39

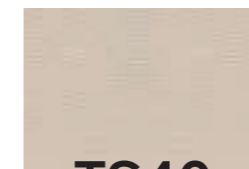

TS40

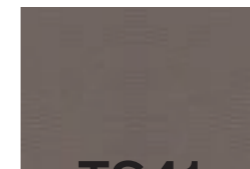

TS41

Feltro

tessuto/fabric

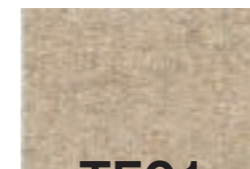

TF01



TF02



TF03



TF07



TF08



TF09



TF11

MANIGLIE — panoramica



A40



A47



A51

A52



A53



A54



A57

A63



A58



A59



A60



A68

A69



A72

A74



A96

HANDLES — overview



A66



A67



A70



A73



A75

MANIGLIE — *panoramica*



HANDLES — *overview*

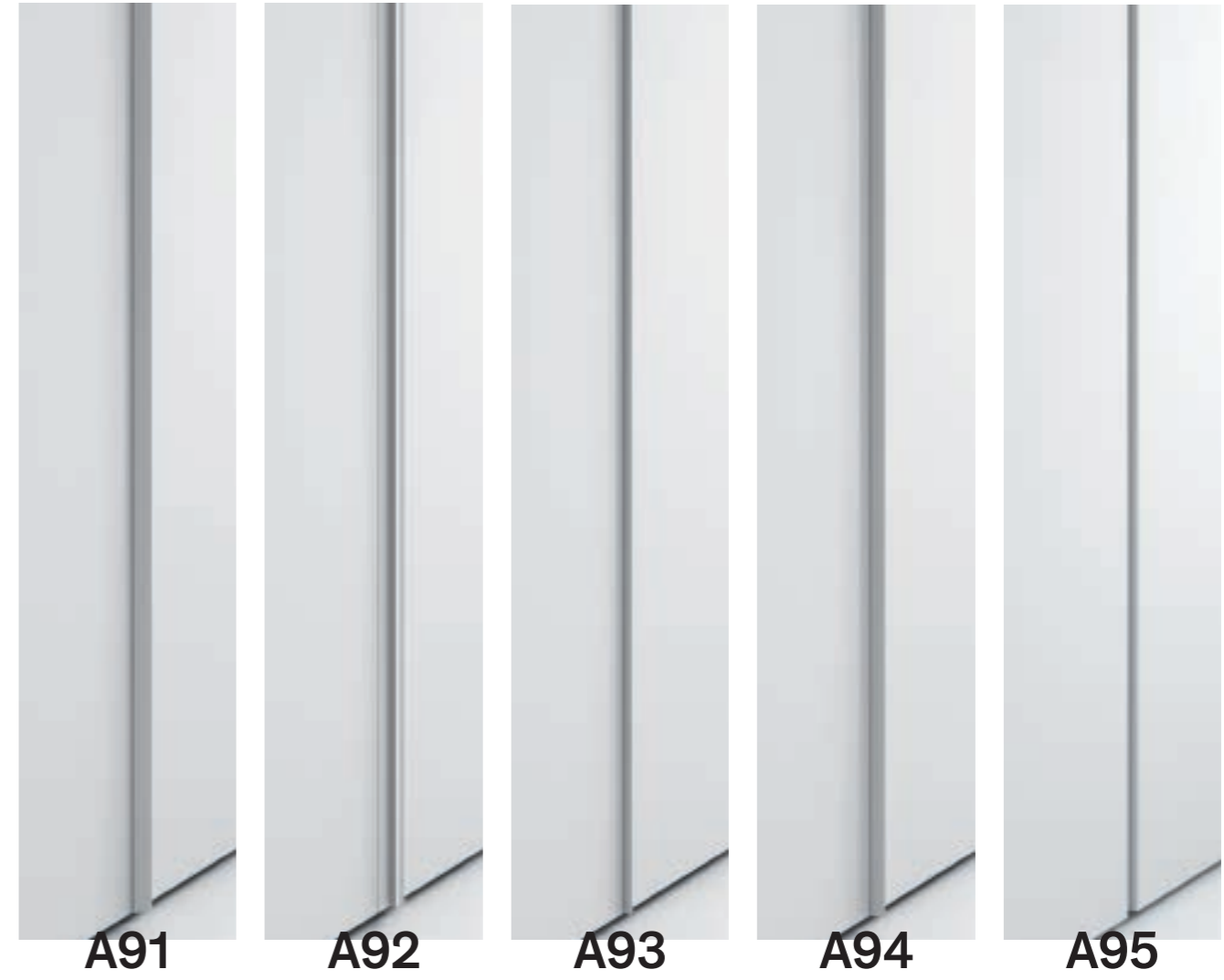

LETTI — *giroletti*

BEDS — *bed surrounds*



R70
dritto/straight



R70
stonato/rounded



R120



R180
dritto/straight



R180
stonato/rounded



R18Z
dritto/straight



R18Z
stonato/rounded



R290
dritto/straight



R290
stonato/rounded

LETTI IMBOTTITI — *giroletti*

PADDED BEDS — *bed surrounds*



**Kora,
Thika**



**Isla,
Jerez,
York**

LETTI — *testiere*

BEDS — *headboards*



Este



Suez



Suez
maxi



Thun



Malè



Gabes



Lagos



Cardiff



Turca

LETTI IMBOTTITI — *testiere*

PADDED BEDS — *headboards*



Kora



Thika



Isla



Jerez



York

LETTI — *panoramica***Suez**

In finitura olmo shade,
con giroletto R120 stondato.

In olmo shade finish with
rounded R120 surround.

**Este**

In finitura olmo tabacco,
gambe in finitura brunito,
con giroletto R70 stondato.

In olmo tabacco finish,
bronze finish legs, with
rounded R70 surround.

**Suez Maxi**

In finitura cemento, gambe
in finitura brunito, con
giroletto R180 stondato.

In cemento finish,
bronze finish legs, with
rounded R180 surround.

BEDS — *overview***Thun**

In finitura cashmere,
con giroletto R290 stondato.

In cashmere finish, with
rounded R290 surround.

INFO

Le testiere sono combinabili
con tutti i giroletti e sono
disponibili in tutte le finiture.

—
Bed headboards can be
used in conjunction
with all surrounds and
are available in all finishes.

**Malè**

In finitura castoro, con
giroletto R18Z stondato.

In castoro finish, with
rounded R18Z surround.

LETTI — *panoramica***Cardiff**

In finitura olmo nordico, gambe in finitura bianco, con giroletto R180 dritto.

In olmo nordico finish, bianco finish legs, with straight R180 surround.

**Gabes**

In finitura canapa, gambe in finitura bianco, con giroletto R70 dritto.

In canapa finish, bianco finish legs, with straight R70 surround.

**Lagos**

In finitura sabbia, testiera in tessuto Charlie TC06, con giroletto R290 dritto.

In sabbia finish, Charlie TC06 fabric headboard, with straight R290 surround.

BEDS — *overview***INFO**

Le testiere sono combinabili con tutti i giroletti e sono disponibili in tutte le finiture. La testiera Lagos è disponibile in tutti i tessuti. Turca è disponibile con giroletto R120 in tutte le finiture.

—
Bed headboards can be used in conjunction with all surrounds and are available in all finishes.

The Lagos headboard is available in all fabrics. Platform bed can be used in conjunction with R120 surround and is available in all finishes.

**Turca**

In finitura bianco, con giroletto R120.

Platform bed in bianco finish, with R120 surround.

LETTI IMBOTTITI — *panoramica***Isla**

Letto imbottito
in tessuto Maia TM08.

Padded bed covered
in Maia TM08 fabric.

**Jerez**

Letto imbottito
in tessuto Maia TM40.

Padded bed covered
in Maia TM40 fabric.

PADDED BEDS — *overview***Thika**

Letto imbottito
in tessuto Tex TT10.

Padded bed covered
in Tex TT10 fabric.

INFO

Kora, Thika, Isla, Jerez,
York e Turca sono disponibili
in tutti i tessuti.

—
The Kora, Thika, Isla,
Jerez, York and platform beds
are available in all fabrics.

**York**

Letto imbottito
in tessuto Tex TT30.

Padded bed covered
in Tex TT30 fabric.

**Turca**

Letto imbottito in tessuto
Maia TM08.

Platform padded bed
covered in Maia TM08
fabric.

**Kora**

Letto imbottito
in tessuto Tex TT06.

Padded bed covered
in Tex TT06 fabric.

COMÒ, COMODINI E SETTIMINI — *panoramica*



Atene

CHESTS OF DRAWERS, BEDSIDE TABLES AND TALLBOYS — *overview*

INFO

Praga e Oslo sono disponibili anche senza maniglia.

—
Praga and Oslo are available also without handle.



Praga



Oslo

COMÒ, COMODINI E SETTIMINI — *panoramica*



Londra



Bilbao

CHESTS OF DRAWERS, BEDSIDE TABLES AND TALLBOYS — *overview*



Bonn

ATTREZZATURE PER ARMADI E CABINE — panoramica

WARDROBE AND WALK-IN WARDROBE FITTINGS — overview

**1.**

Servetto appendiabiti estensibile in alluminio.
—
Extending aluminium clothes lift.

2.

Crociera interna.
—
Pigeon holes.

3.

Tubo appendiabiti in alluminio.
—
Aluminium hanging rail.

4.

Divisorio verticale e cassettera interna, scarpiera estraibile.
—
Internal vertical partition and drawer unit, pull-out shoe rack.

5.

Portapantaloni in alluminio, vassoi e vaschette svuotatasche estraibili.
—
Pull-out aluminium trouser rack, trays and organizer trays.

6.

Cassettera interna, divisorio verticale interno, ripiani interni, tubo appendiabiti in alluminio.
—
Internal drawer unit, internal vertical partition, internal shelves, aluminium hanging rail.

7.

Ripiani interni.
—
Internal shelves.

8.

Sacca portabiancheria, vassoio e cestello laterale estraibili.
—
Pull-out laundry bag, tray and side rack.

art direction and graphics
dogtrot

colour separation
lucegroup

printed by
lucegroup



cinquanta3

via G. Galilei, 35
31053 Pieve di Soligo TV Italy
T 0039 0438 83 93
F 0039 0438 83 95 55

cinquanta3.it

cinquanta3 è un progetto di
Battistella company.

—
cinquanta3 is a project by
Battistella company.

battistella.it

e la modularità di

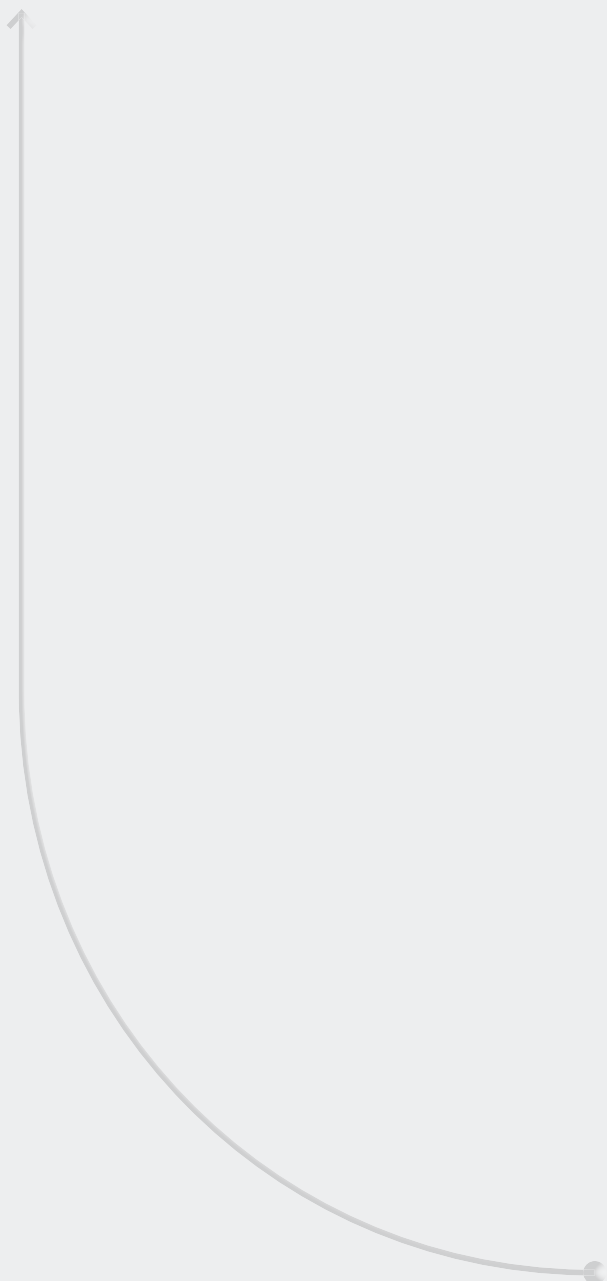

progettate

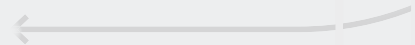

attraverso
la flessibilità

